

mm をおぼえよう♪

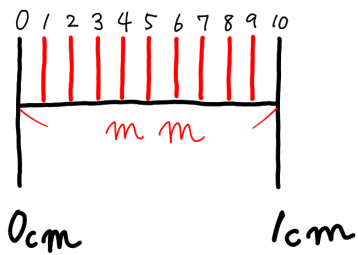

10 mm は 1 cm
20 mm は 2 cm

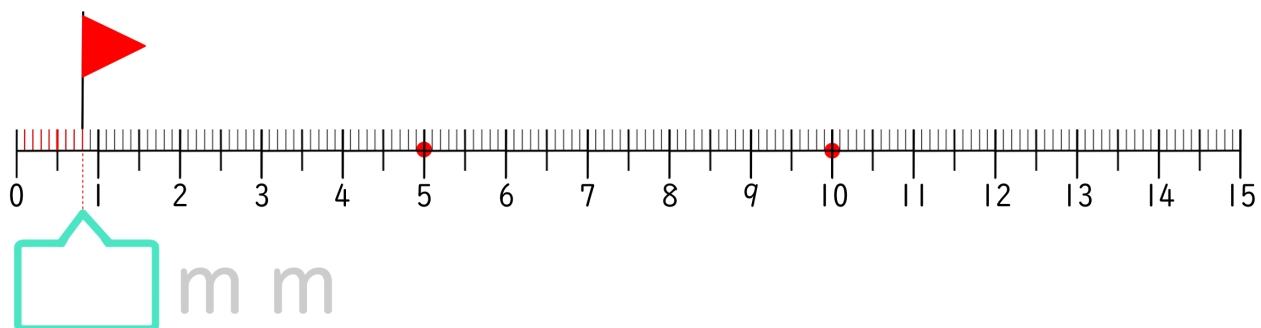
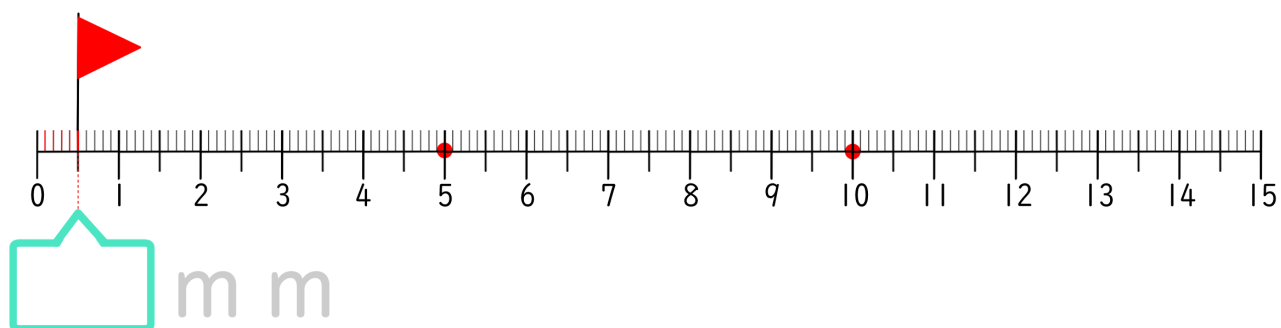
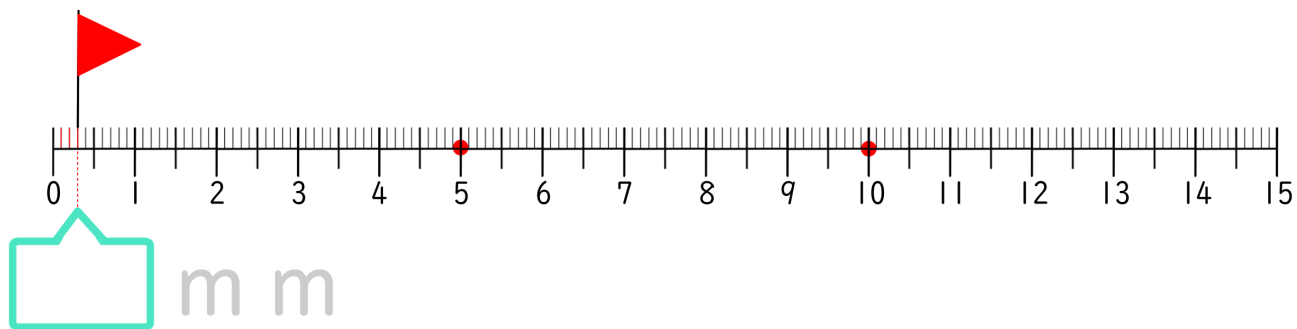
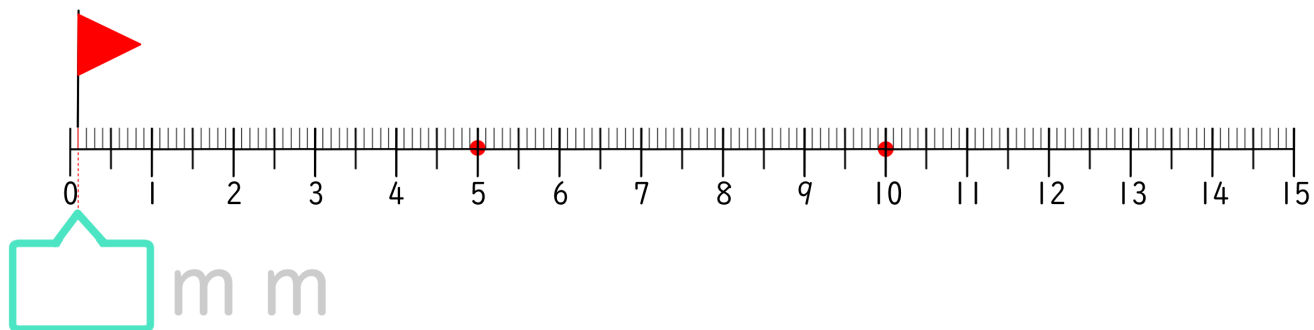
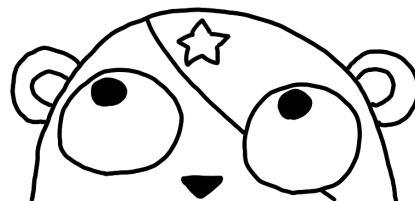

mm をおぼえよう♪

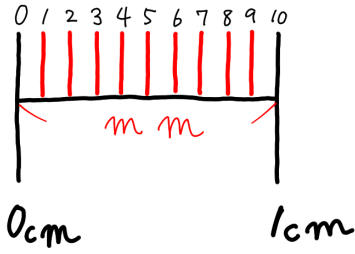

10 mm は 1 cm
20 mm は 2 cm

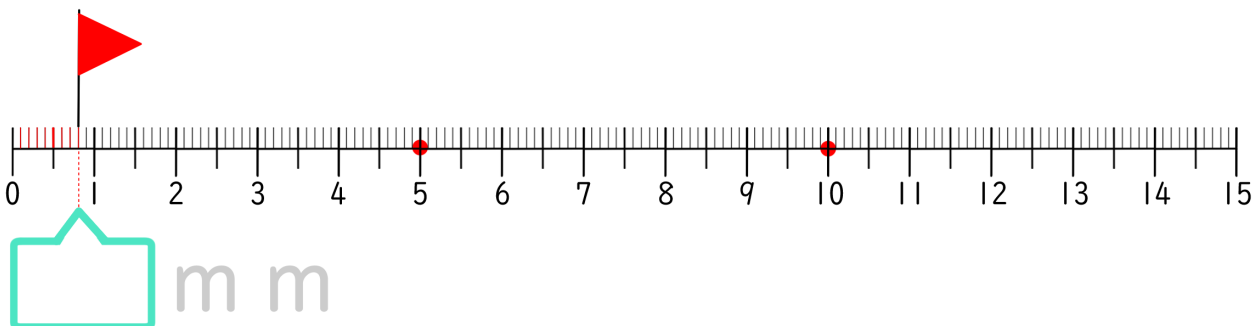
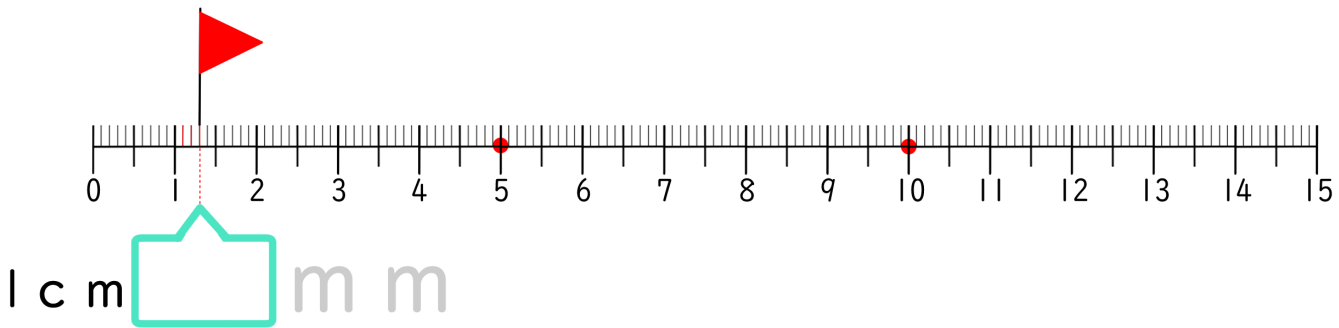
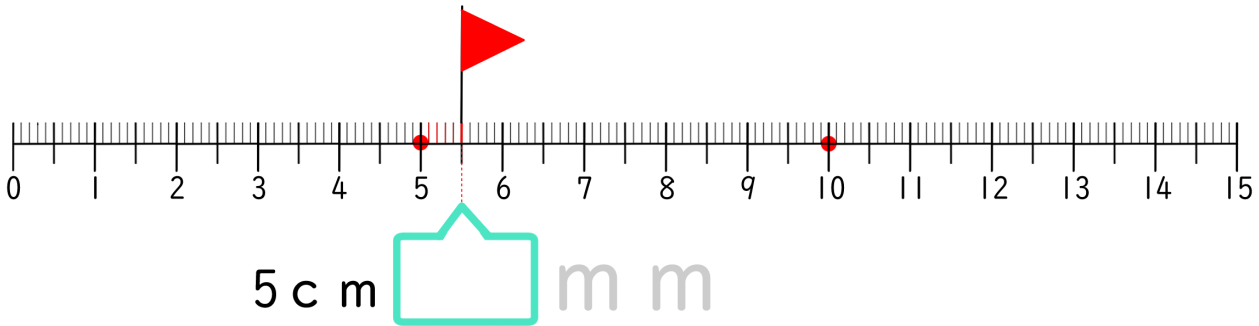
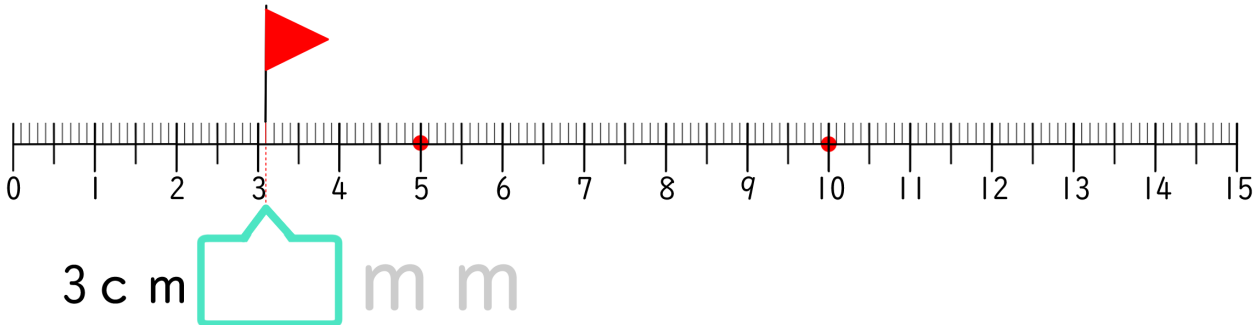
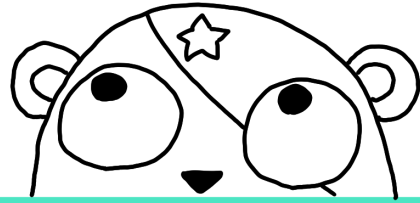

mm をおぼえよう♪

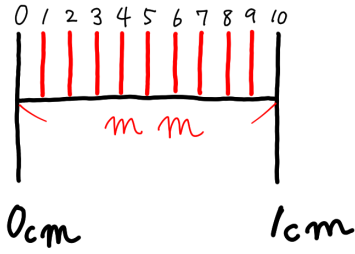

10 mm は 1 cm
20 mm は 2 cm

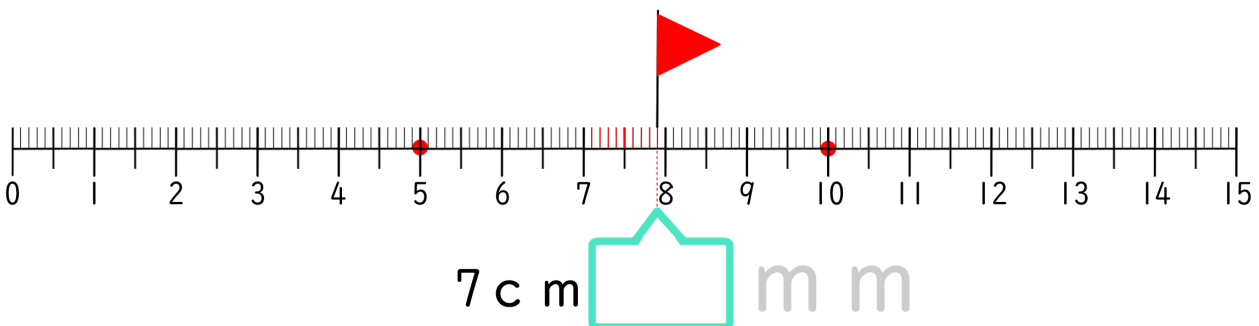
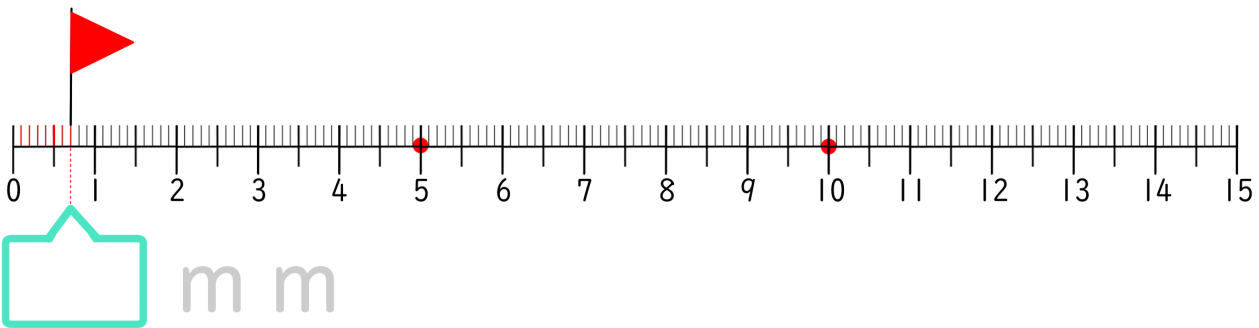
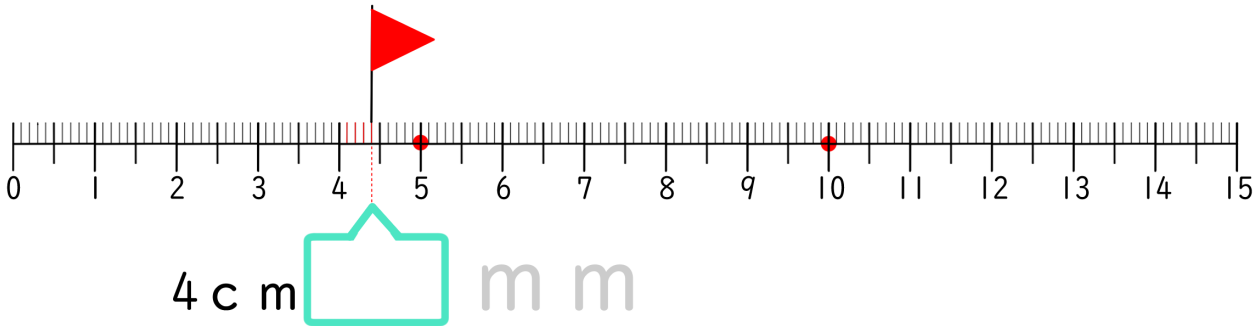
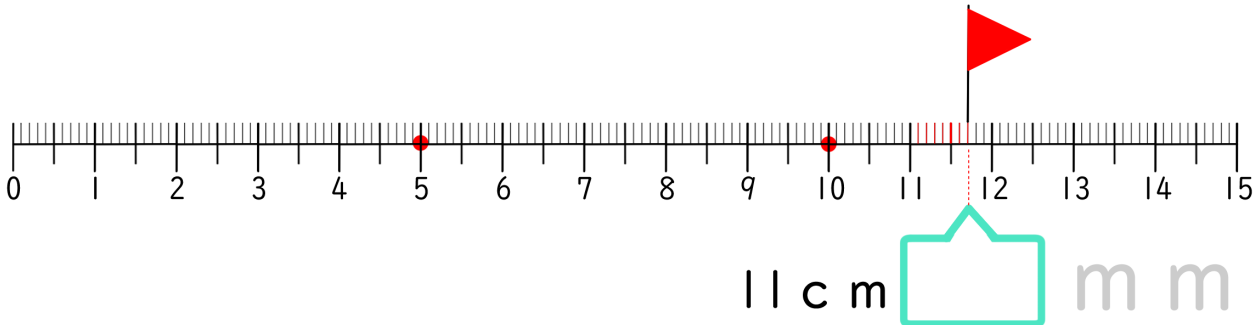

mm をおぼえよう♪

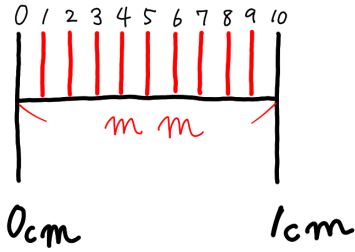

10mm は 1cm
20mm は 2cm



mm

mm

mm

mm

mm をおぼえよう♪

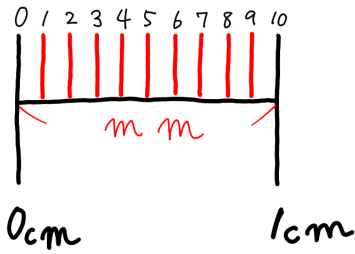

10 mm は 1 cm
20 mm は 2 cm

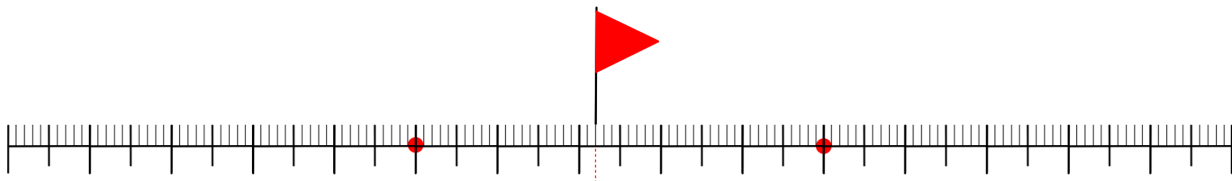

7 cm mm

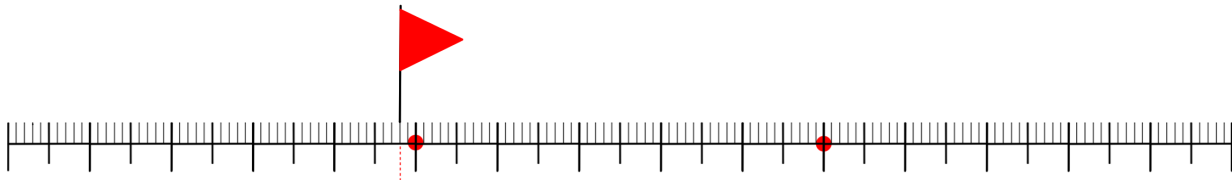

4 cm mm

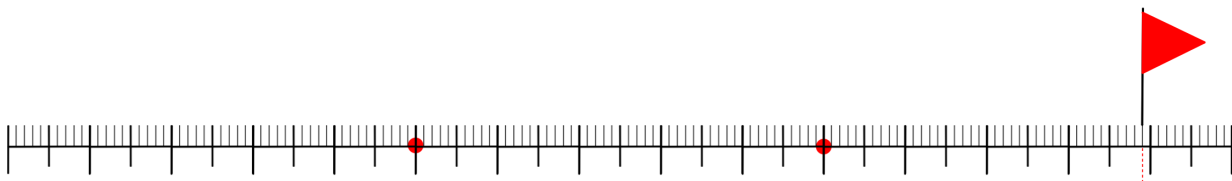

13 cm mm

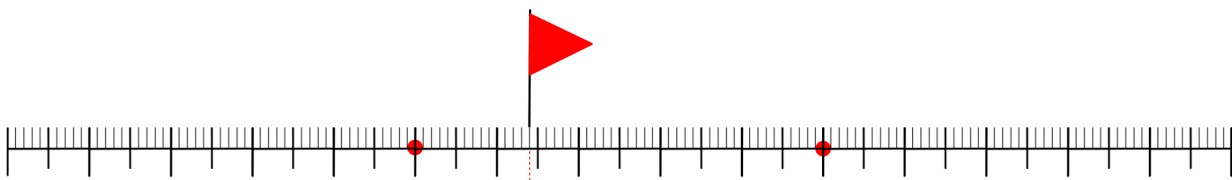

6 cm mm

mm をおぼえよう♪

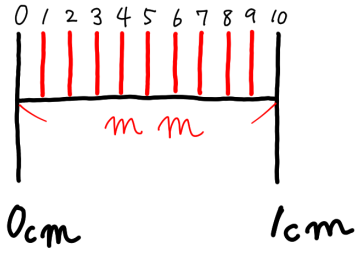

10 mm は 1 cm
20 mm は 2 cm

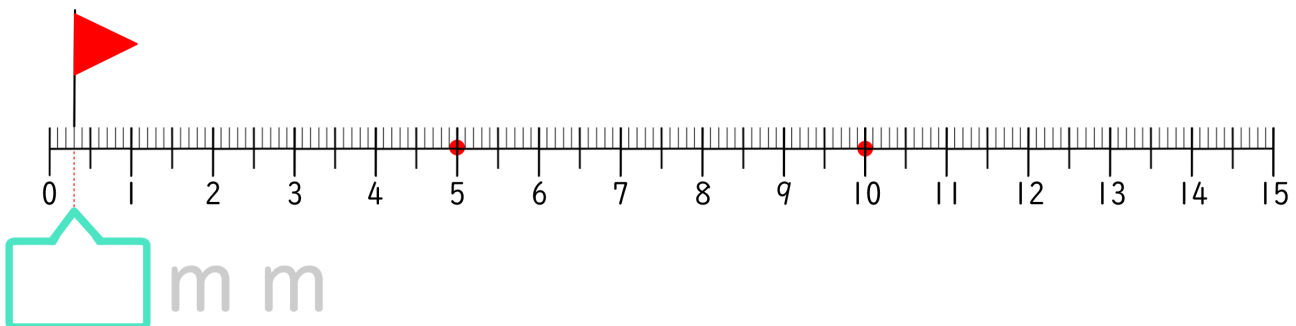
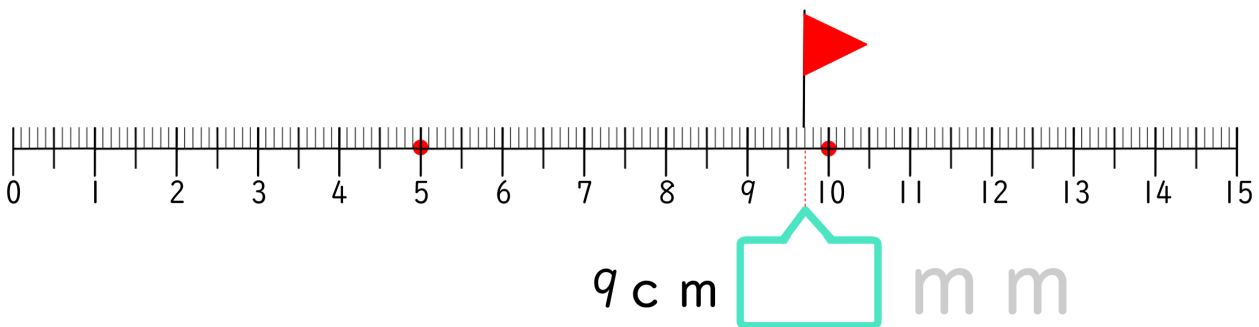
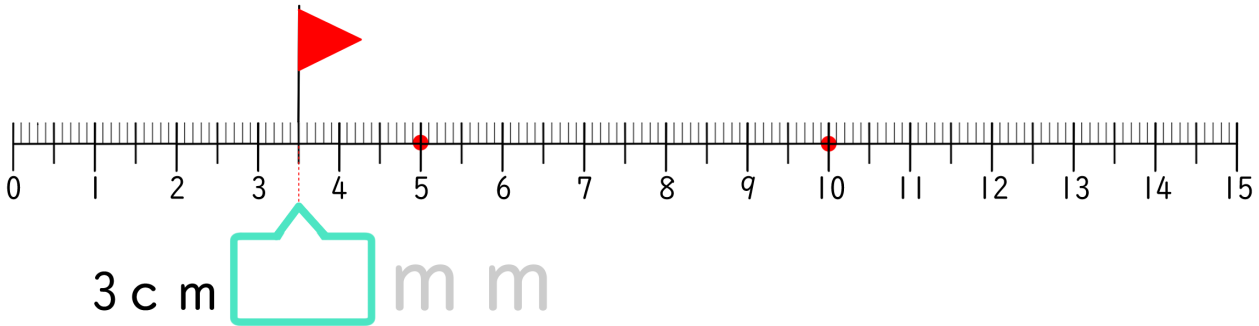
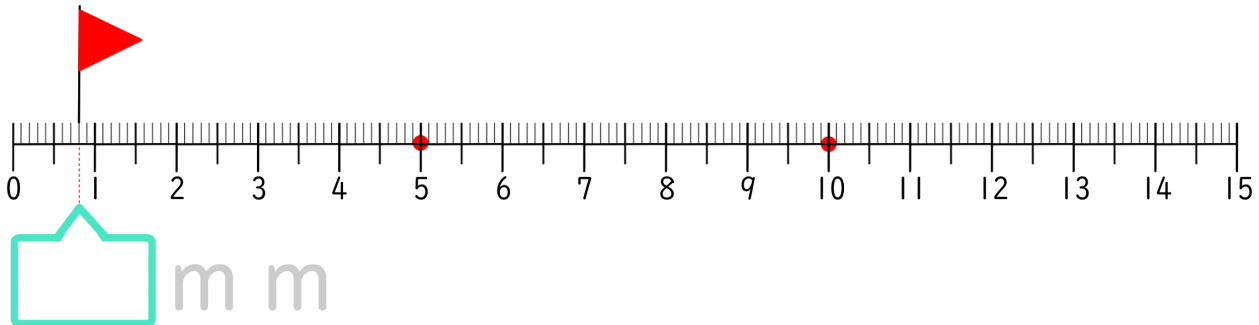
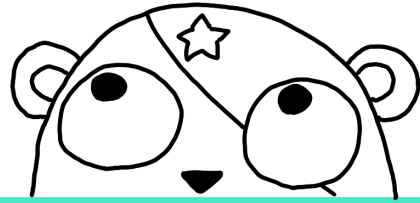

ながさのプリント

なまえ

①ものさしやじょうぎをつかってはかろう♪



3cm



3cm

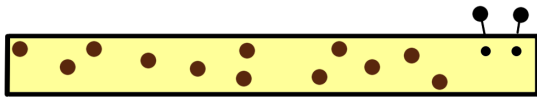

3cm

②ものさしやじょうぎをつかってせんをかこう♪

3cm

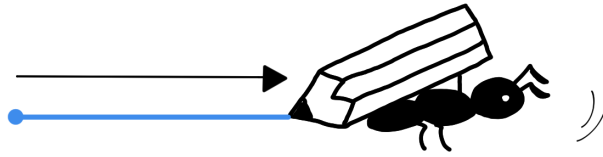

5cm3mm



7cm5mm



3cm7mm



ながさのプリント

なまえ

①ものさし や じょうぎ を つかって はかろう♪



ながさ



ながさ



ながさ

②ものさし や じょうぎ を つかって せん を かこう♪

3cm

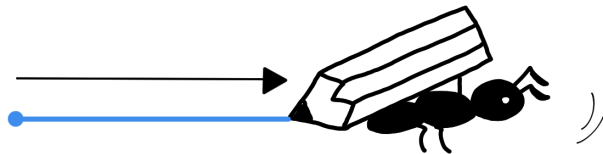

2cm 1mm



6cm 5mm



8cm 7mm



①ものさし や じょうぎ を つかって はかろう♪



3cm



3cm

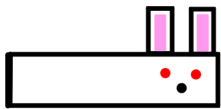

3cm

②ものさし や じょうぎ を つかって せん を かこう♪

3cm

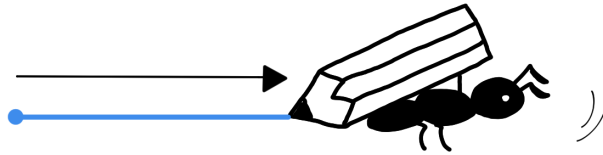

6cm4mm

•

1cm6mm

•

9cm2mm

•

ながさのプリント

なまえ

しゅりけんのところのながさをこたえよう♪

cmとmmもね
センチ ミリ

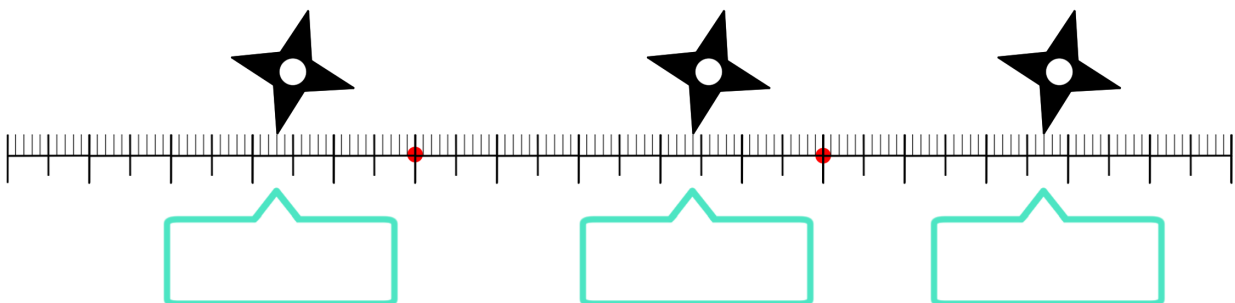
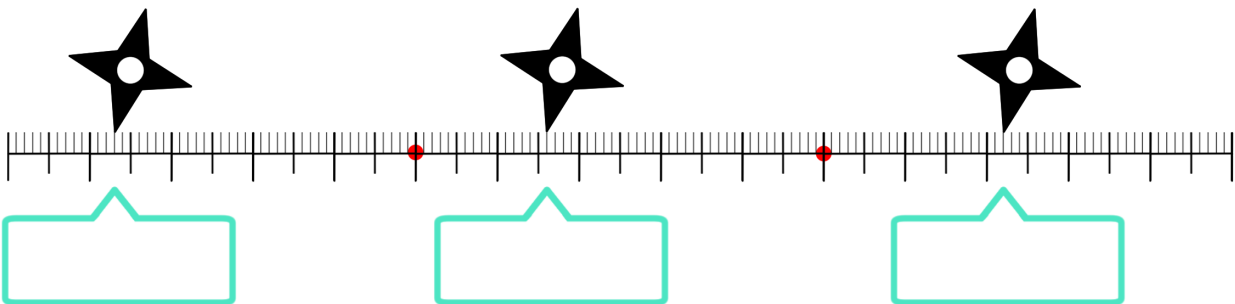
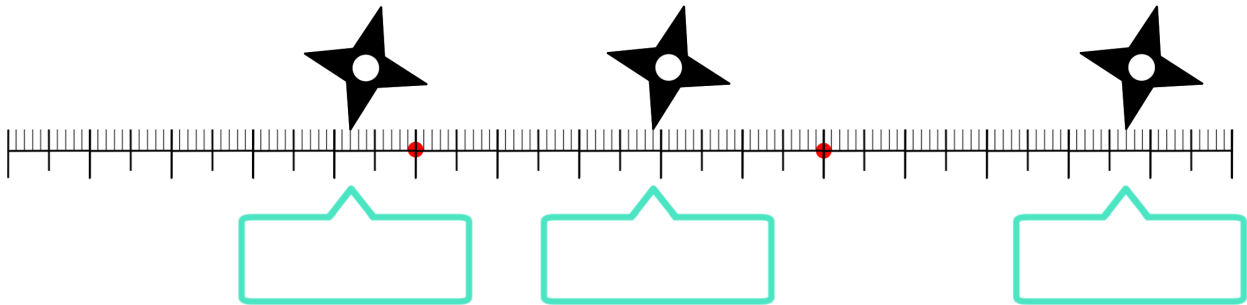
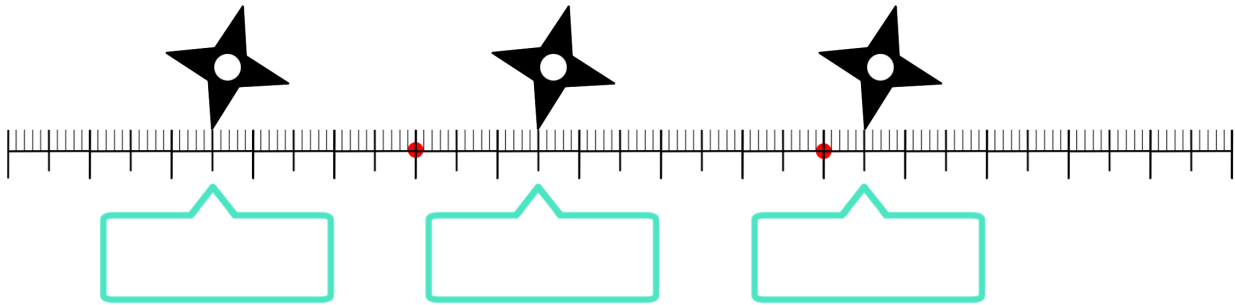
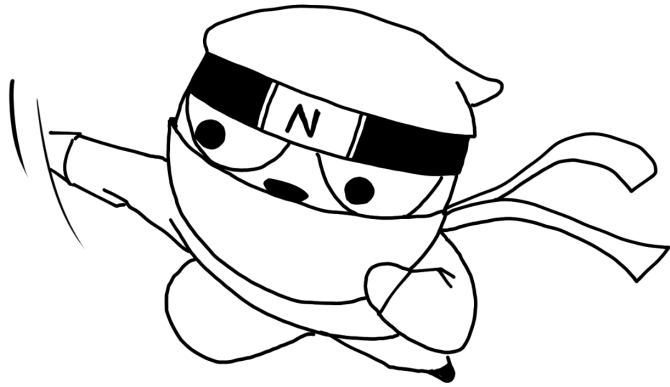

しゅりけんのところのながさをこたえよう♪

cmとmmもね
センチ ミリ

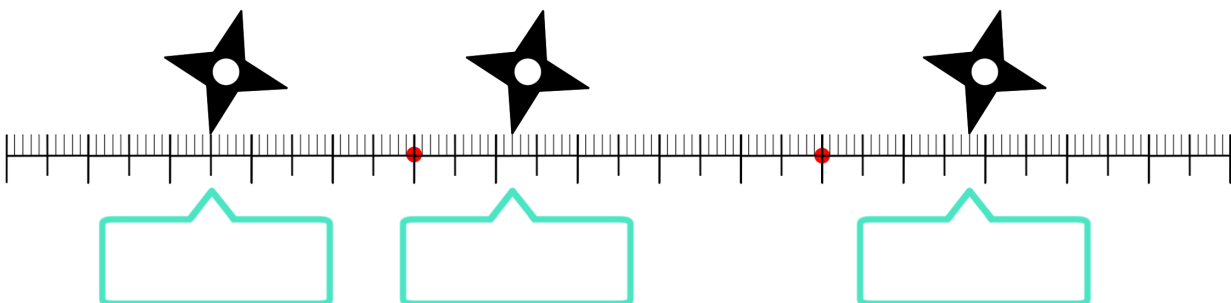
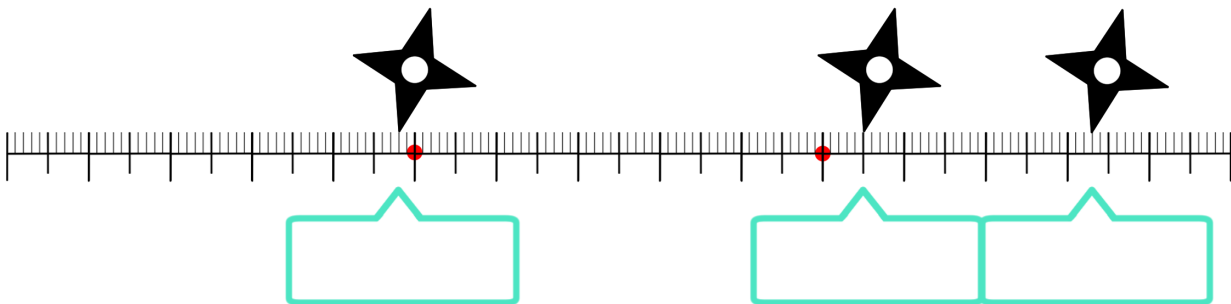
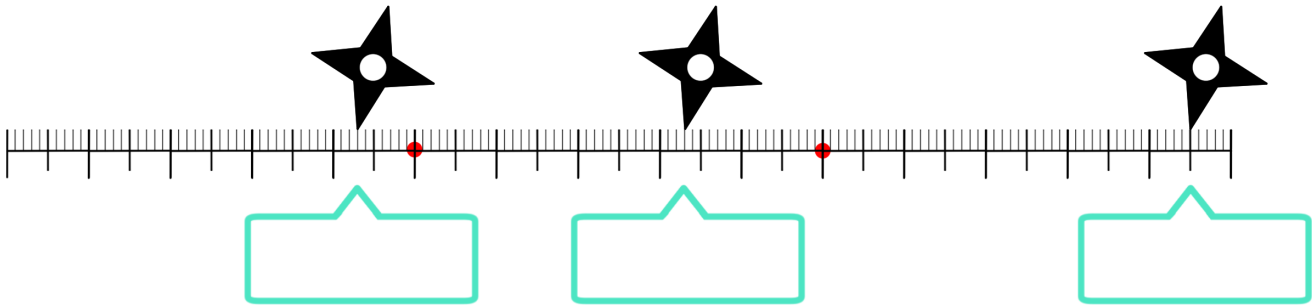
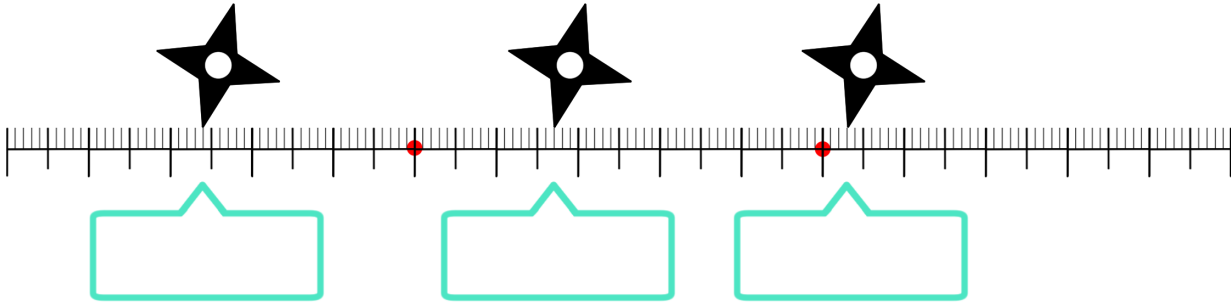
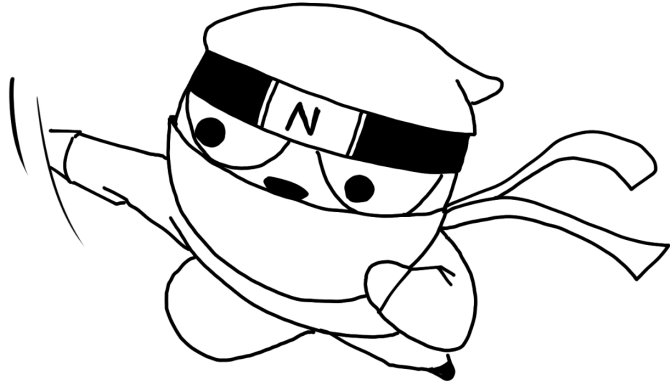

ながさのプリント

なまえ

しゅりけんのところのながさをこたえよう♪

cmとmmもね
センチ ミリ

