

① ^{みず}水かさの ^{いろ}ぶんだけ色をぬってみよう！

3L

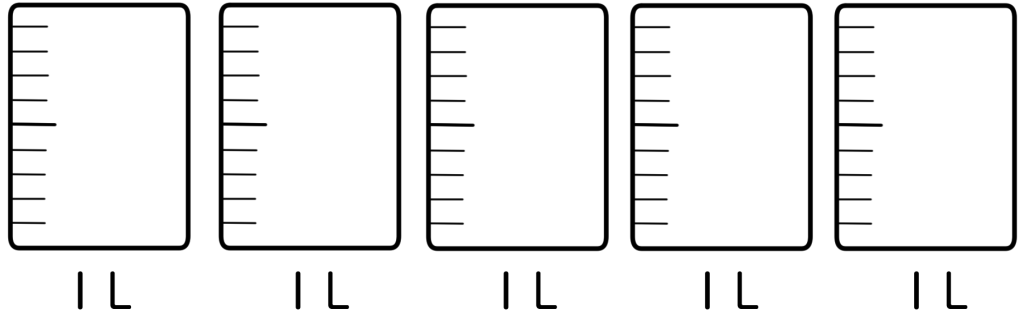

5dL

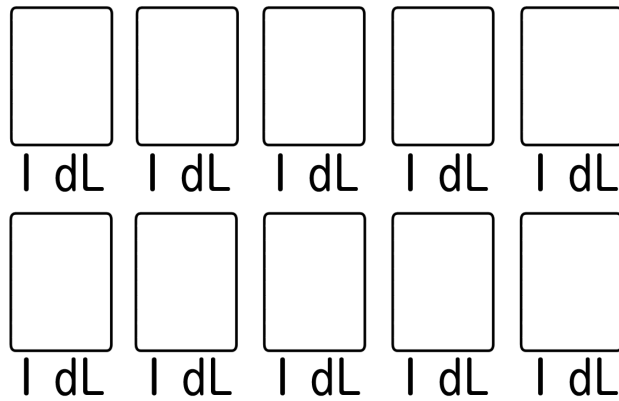

1L3dL

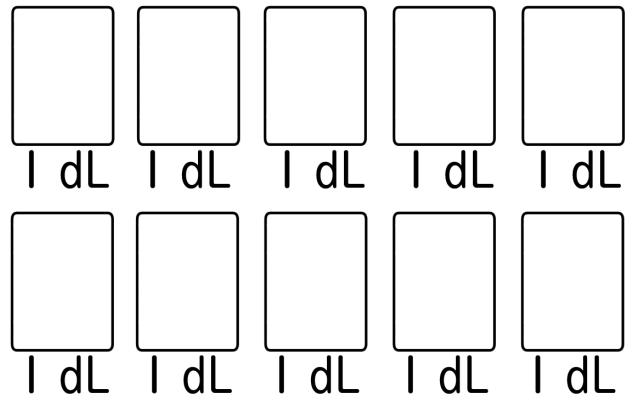

1dL

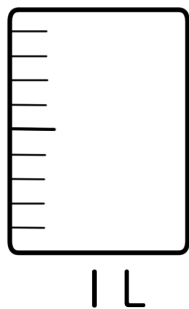

① ^{みず}水かさの ^{いろ}ぶんだけ色をぬってみよう!

2L

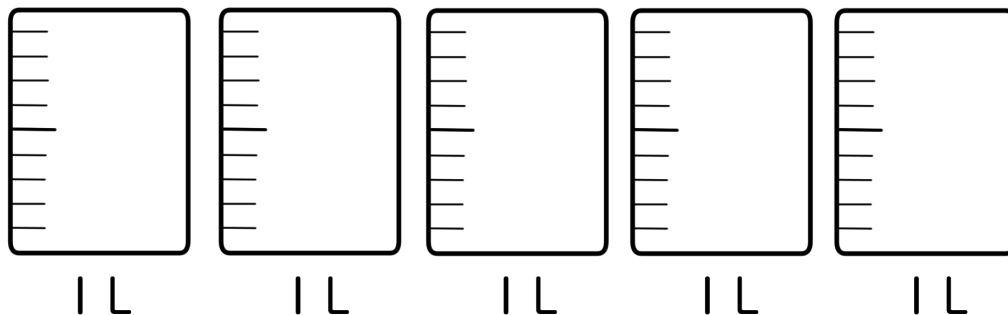

8dL

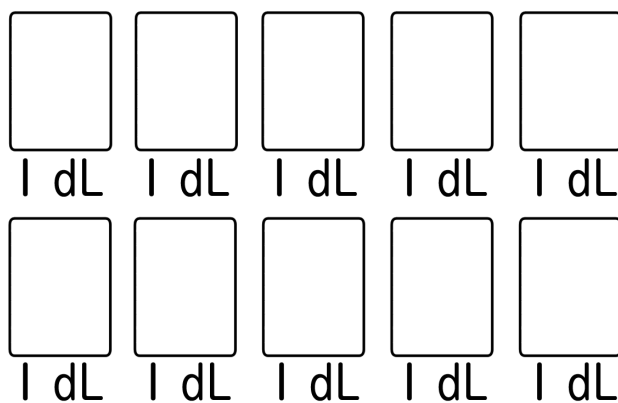

2L5dL

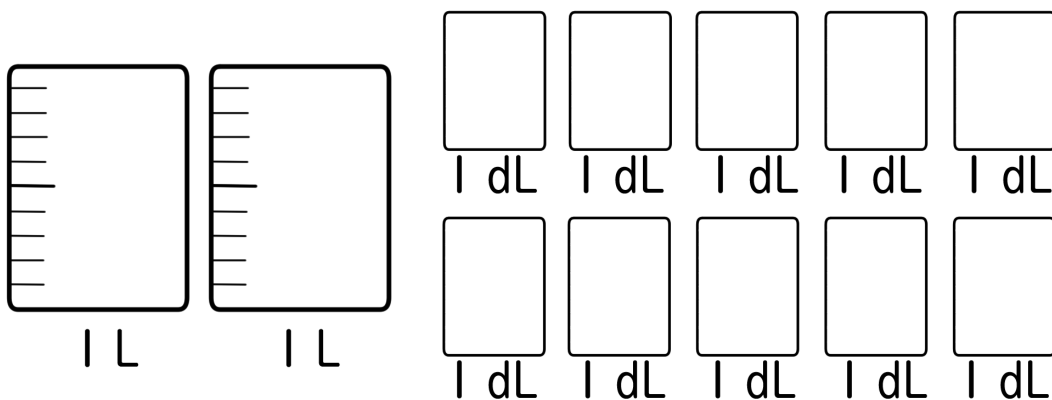

4dL

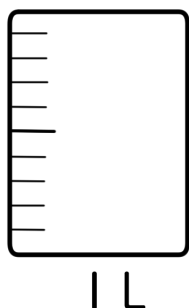

① ^{みず}水かさの ^{いろ}ぶんだけ色をぬってみよう!

5L

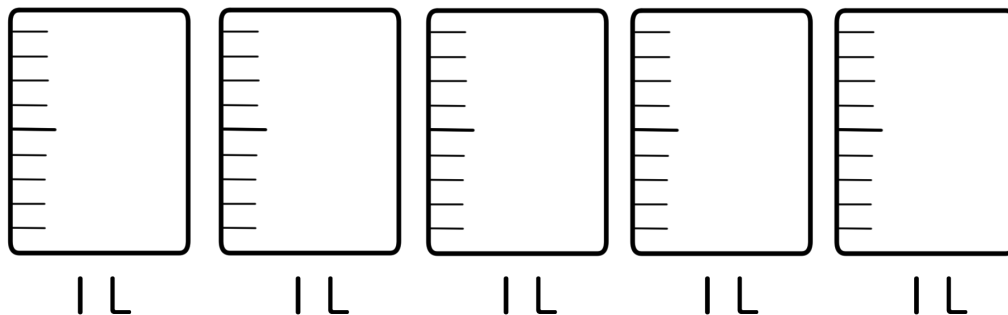

10dL

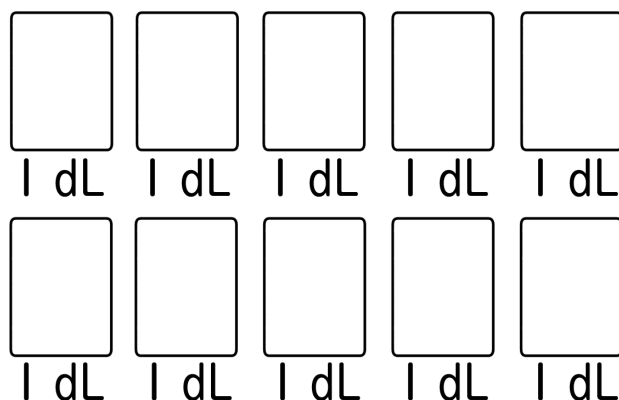
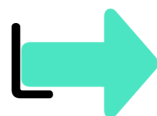

1L9dL

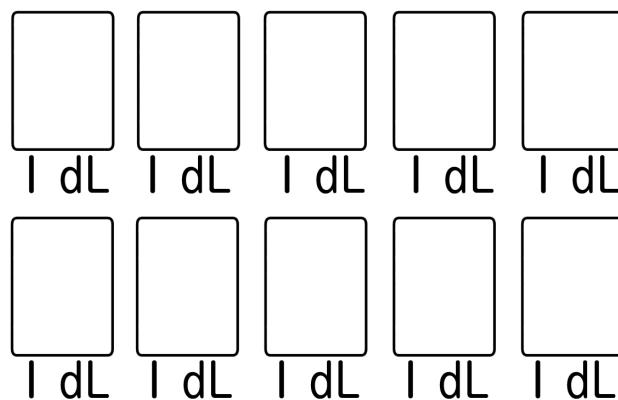
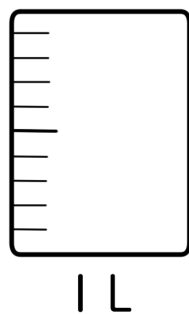

7dL

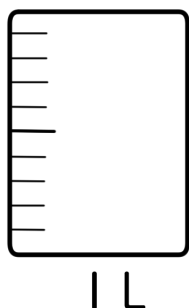

① ^{みず}水の量 ^{りょう}が多い方 ^{おお}は ^{ほう}どっちかな？ ()に丸 ^{まる}を書 ^かいてみよう

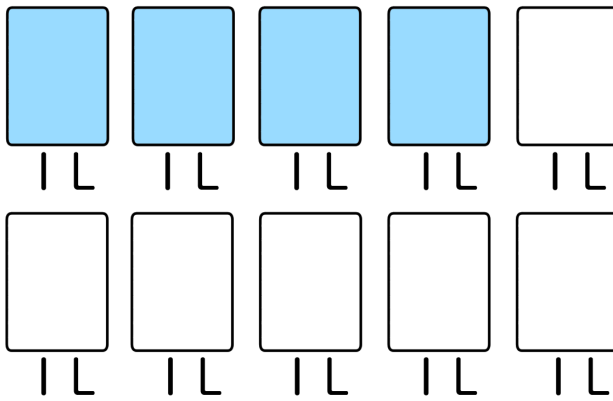
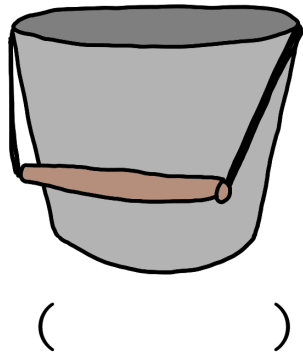
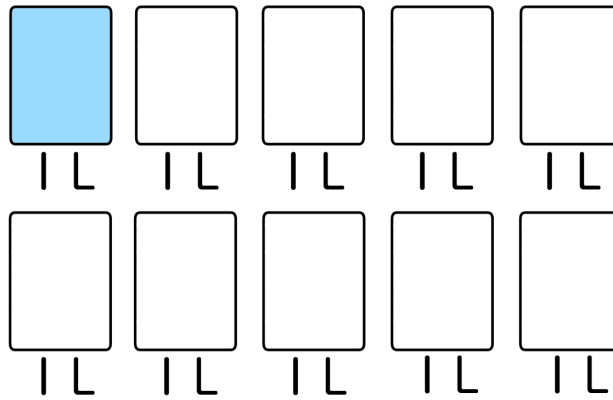
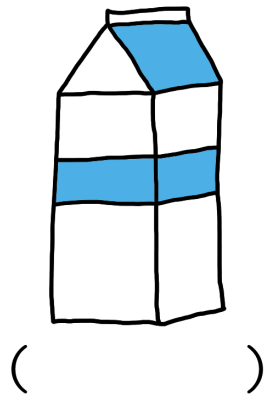

② ^あ合わせると ^{ぜんぶ}ぜんぶで ^{いくつ}いくつ ^{になる}になるかな？

しき

こたえ

③ ^{ちが}ちがいは ^{いくつ}いくつ ^{になる}になるかな？

しき

こたえ

① ^{みず}水の量 ^{りょう}が多い方 ^{おお}は ^{ほう}どっちかな？ ^{まる}()に丸 ^かを書いてみよう

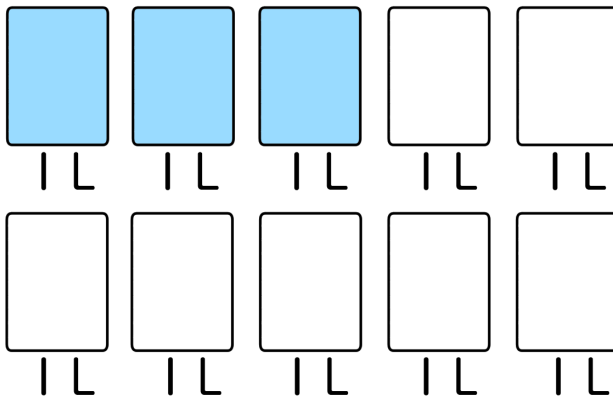
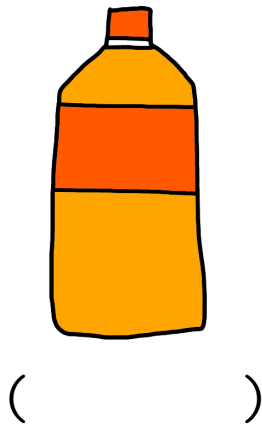
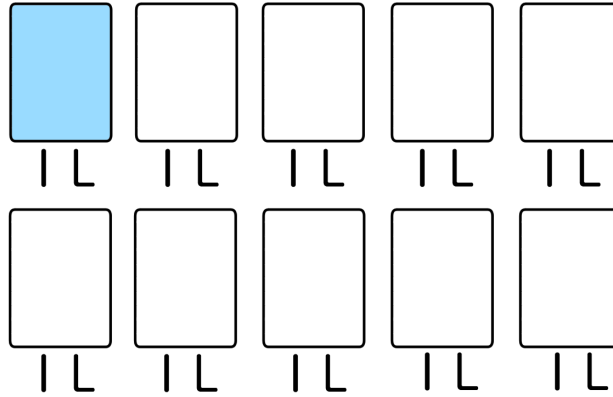
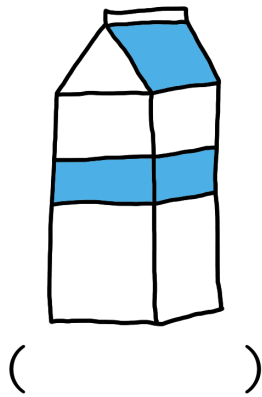

② ^あ合わせると ^{ぜんぶ}ぜんぶで ^{いくつ}いくつ ^{になる}になるかな？

しき

こたえ

③ ^{ちがい}ちがいは ^{いくつ}いくつ ^{になる}になるかな？

しき

こたえ

① ^{みず} ^{りょう} ^{おお} ^{ほう} 水の量が多い方はどっちかな？ ()に ^{まる} ^か 丸を書いてみよう

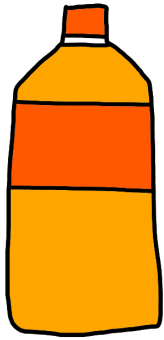

()

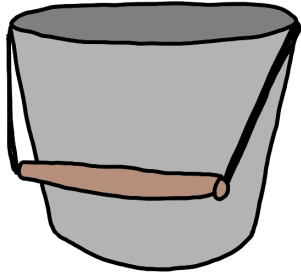
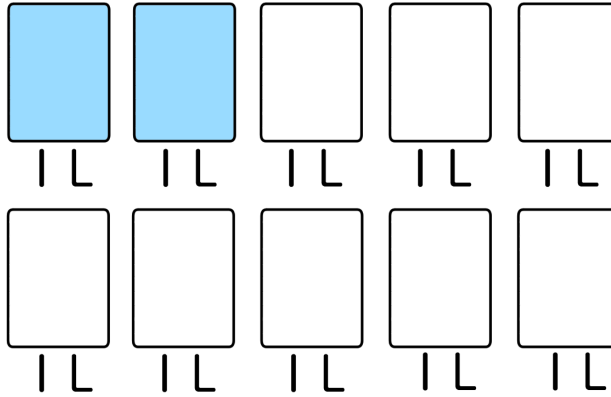

()

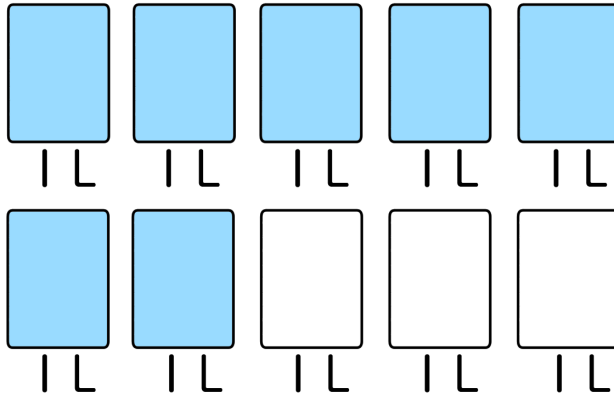

② ^あ 合わせるとぜんぶでいくつになるかな？

しき

こたえ

③ ちがいはいくつになるかな？

しき

こたえ