

かんじプリント

なまえ

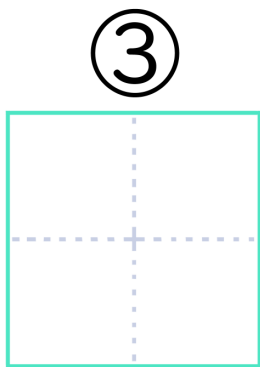
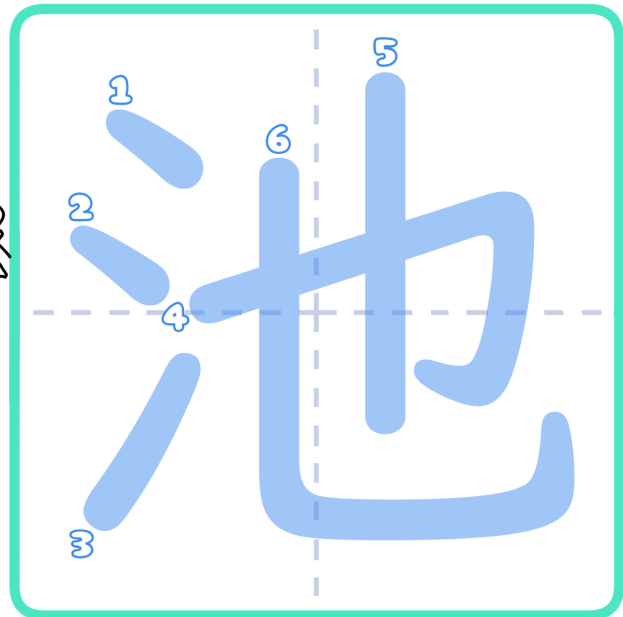
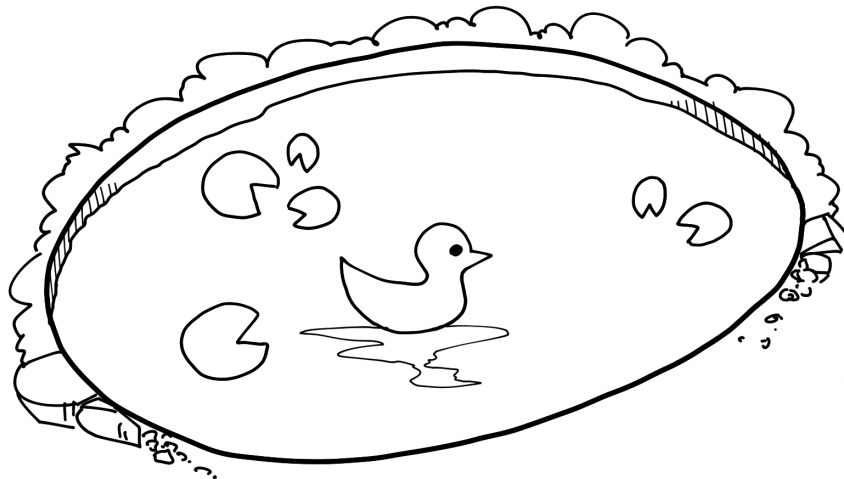

いけ

溜池

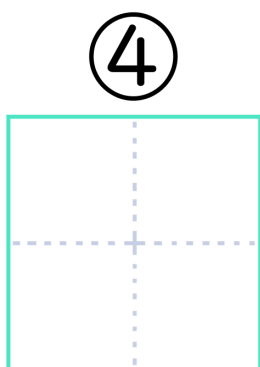

いち

番

① 古池ふるいけ

② 電池でんち

くん
いけ

おん
ち

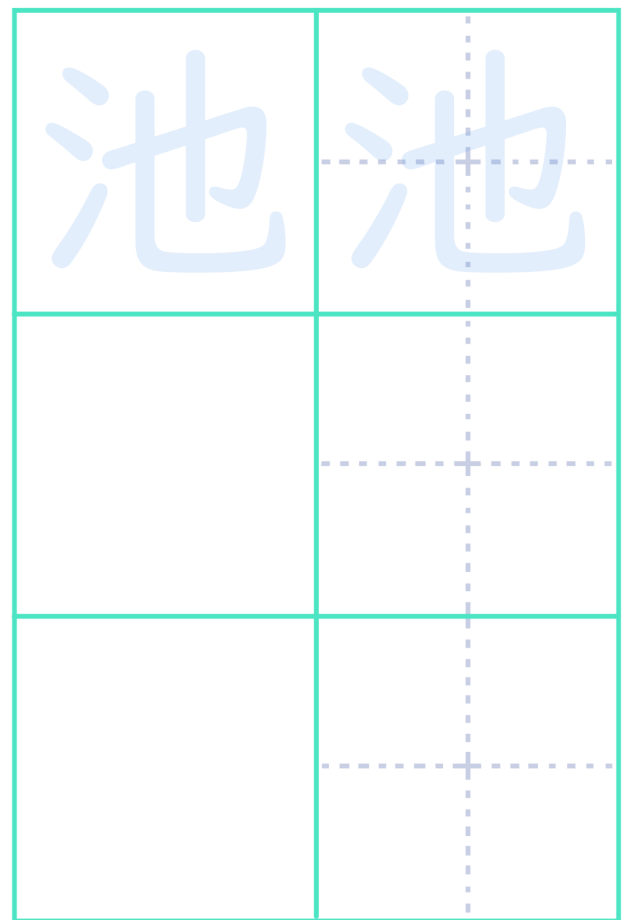

かんじプリント

なまえ

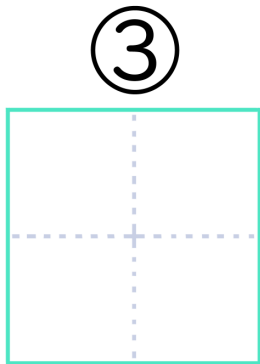
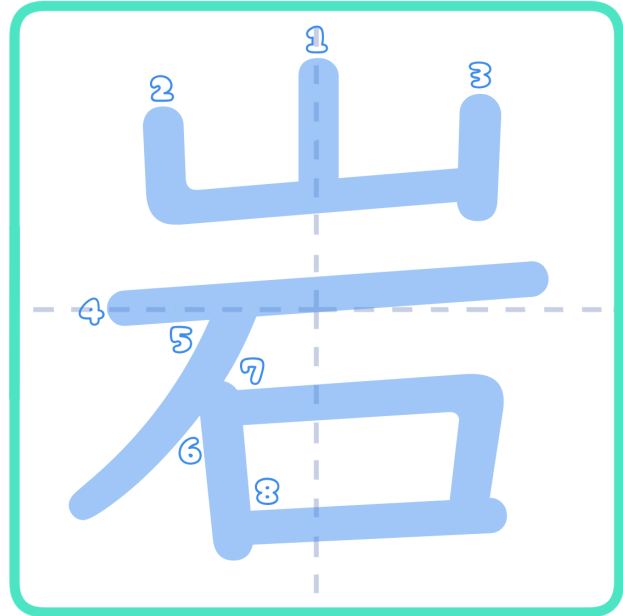

石 せき

がん

① 岩 い
山 やま

くん
いわ

おん
がん

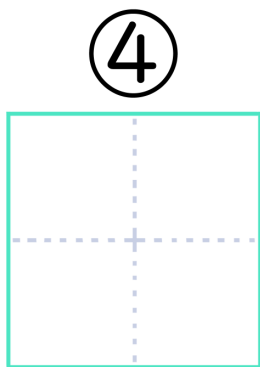

場 ば

いわ

② 溶 よう
岩 い

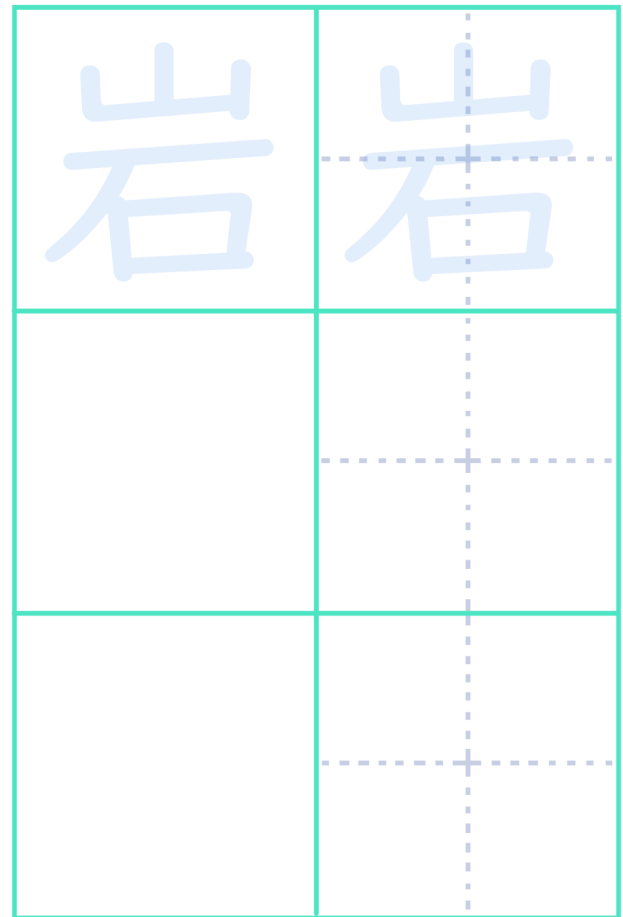

かんじプリント

なまえ

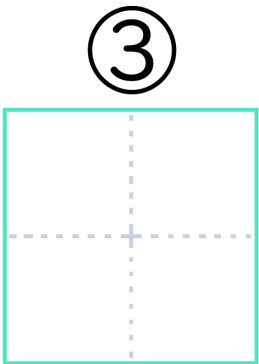
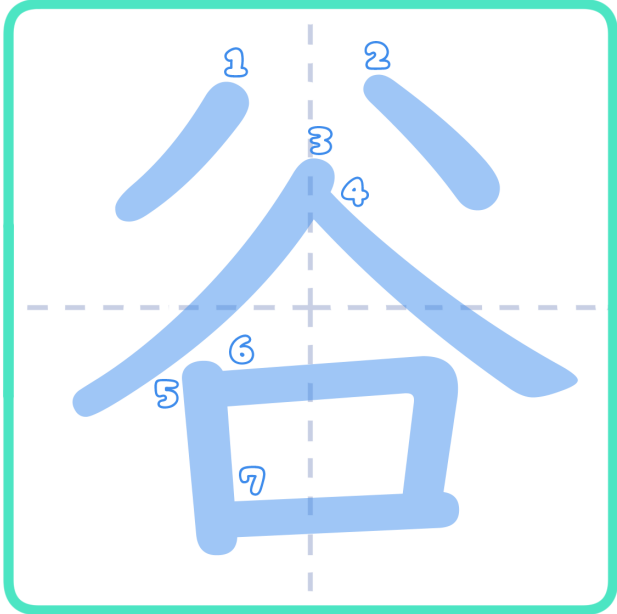
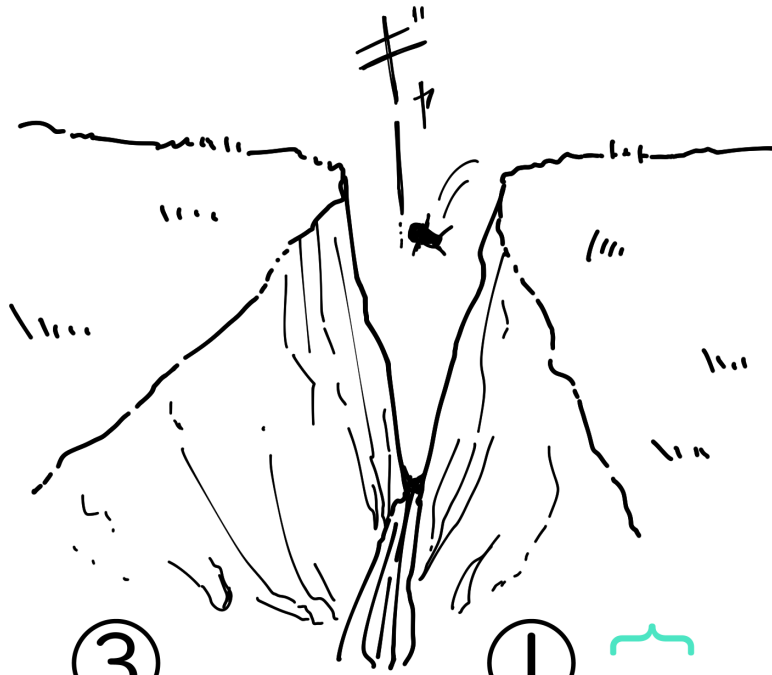

③

たに

川 がわ

① 谷折り お

くん
たに

おん
(こく)

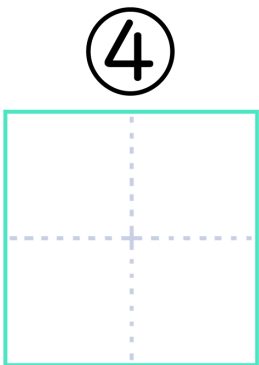

④

たに

間 ま

② 谷底 そこ

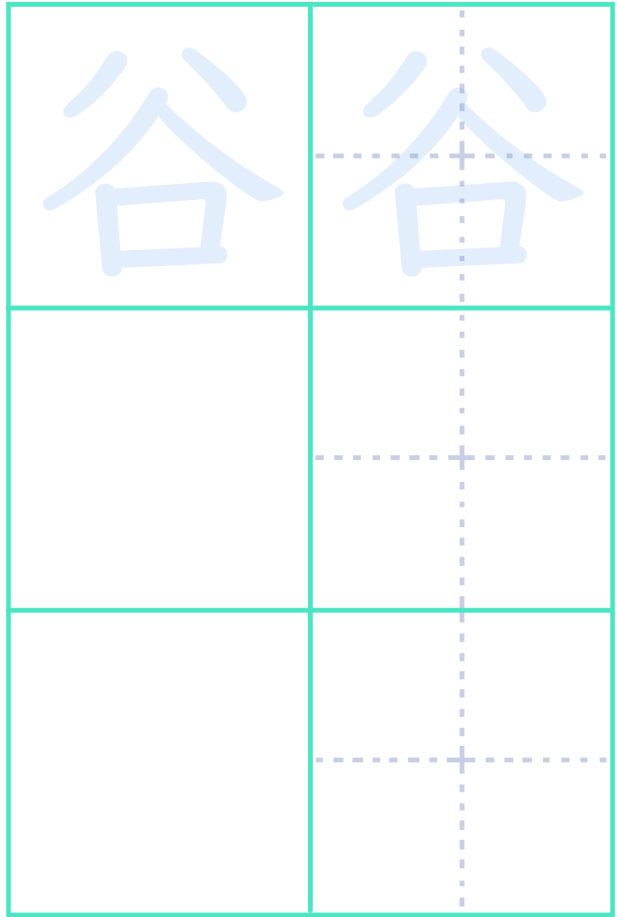

かんじプリント

なまえ

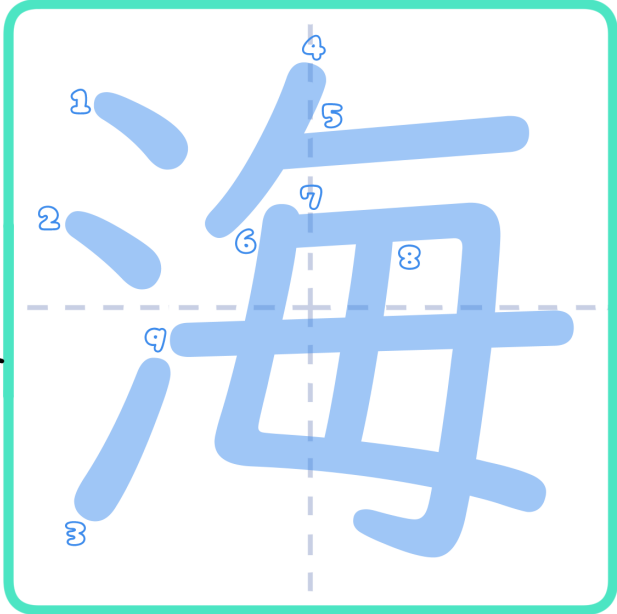
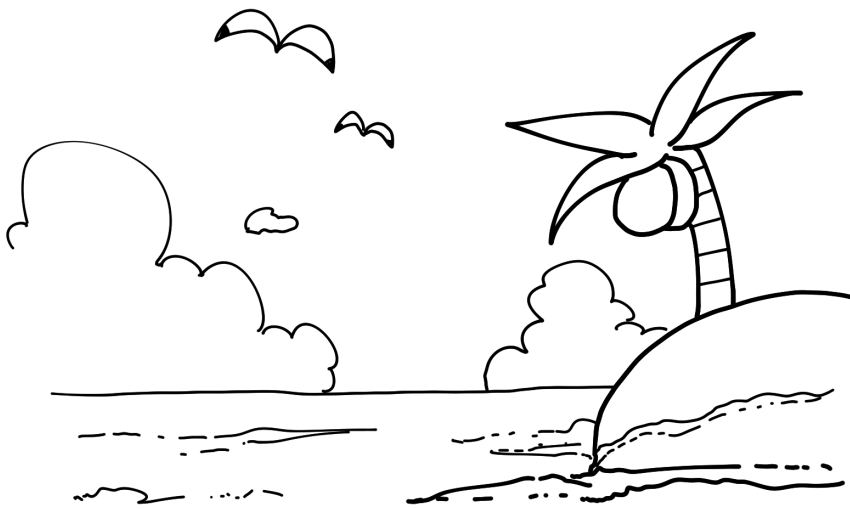

③

かい

草そう

① 海うみで泳およぐ

くん

うみ

おん

かい

④

うみ

辺へ

② 海うみ岸がん

海	海

かんじプリント

なまえ

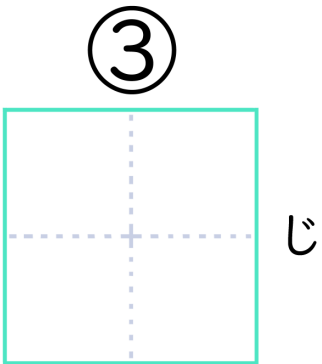
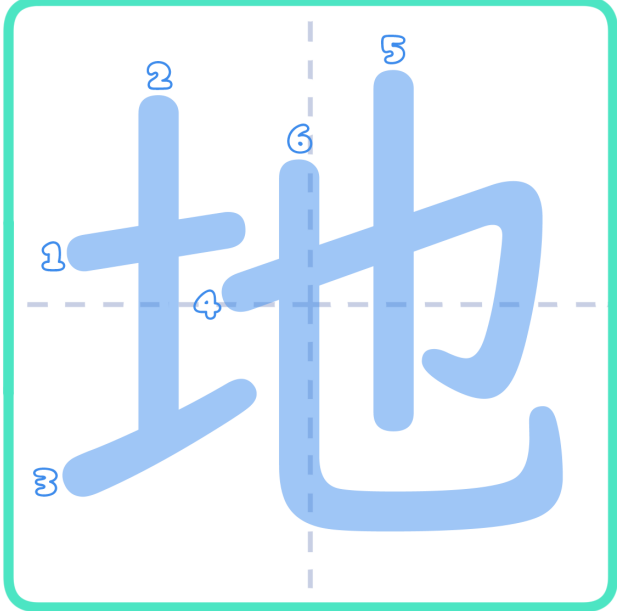

震 しん

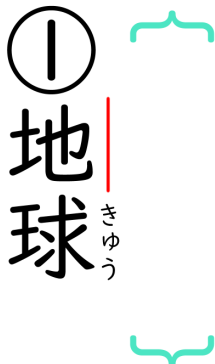

地球 ちゆうきゅう

くん

おん

じち

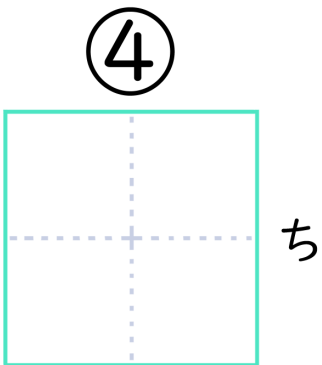

下鉄 かてつ

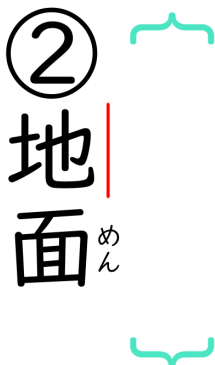

地面 ちめん

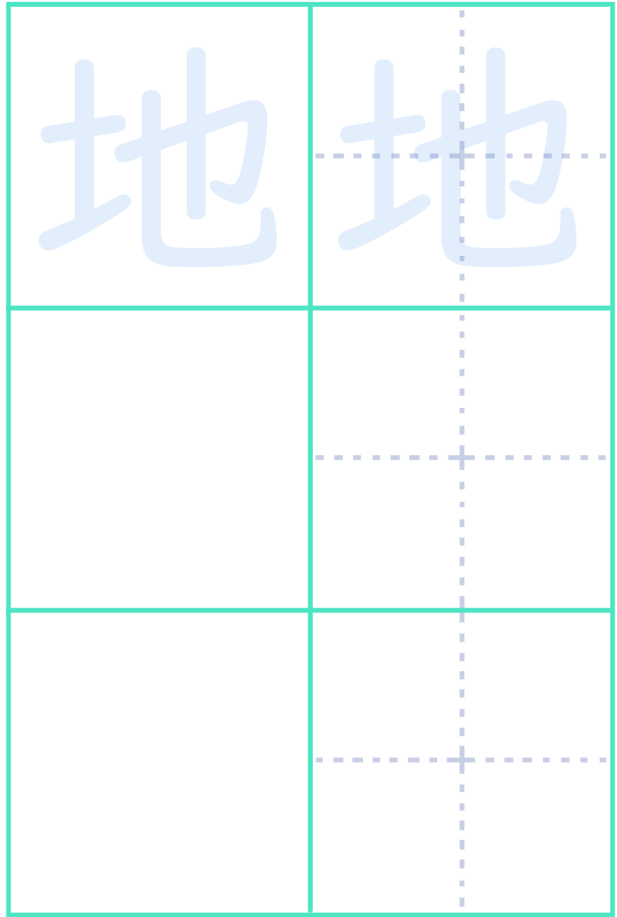

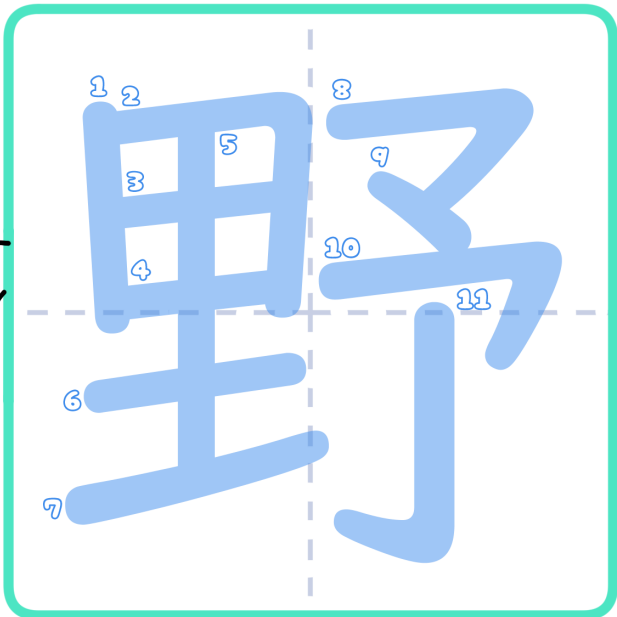
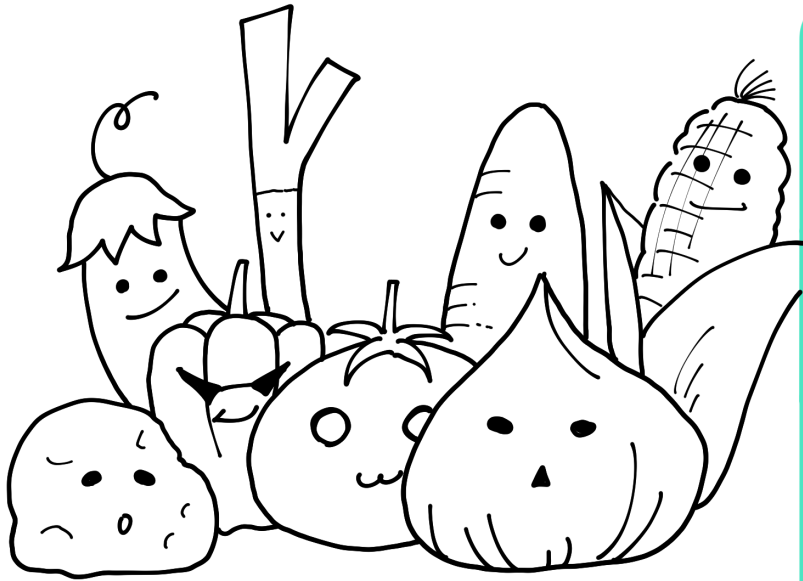

③

や

球 きゅう

① 野原 はら

くん の

おん や

④

の

山 やま

② 野菜 さい

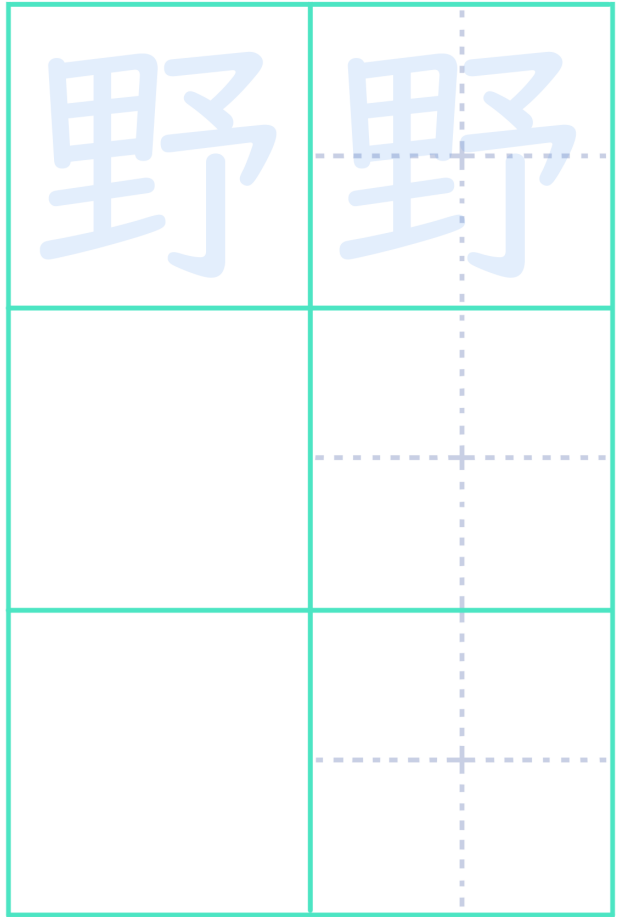

かんじプリント

なまえ

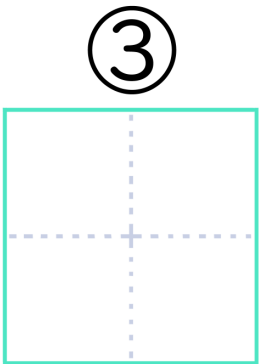
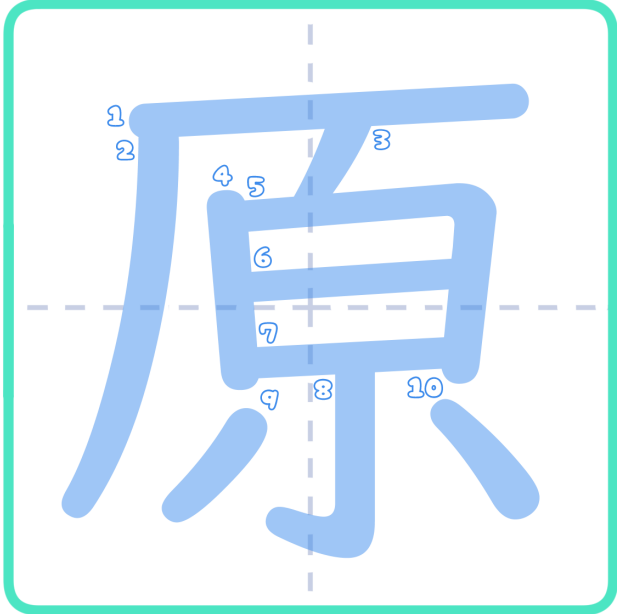
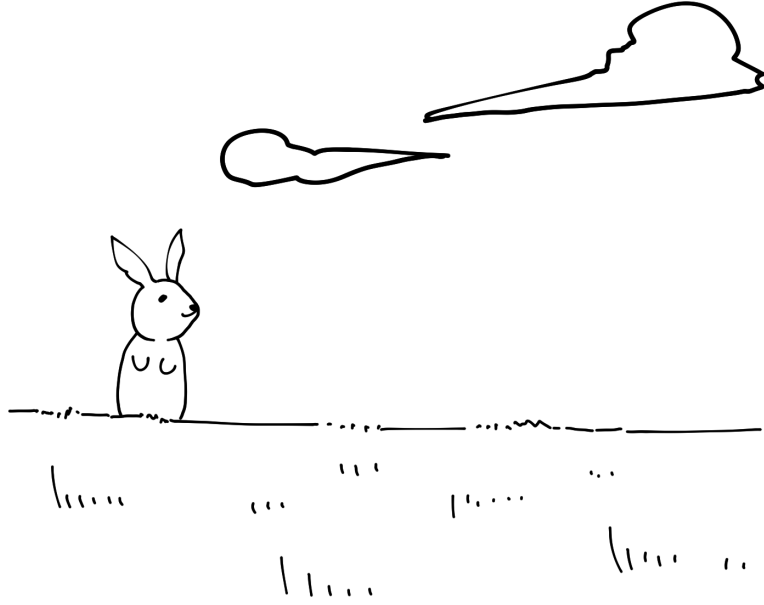

③

はら

つば

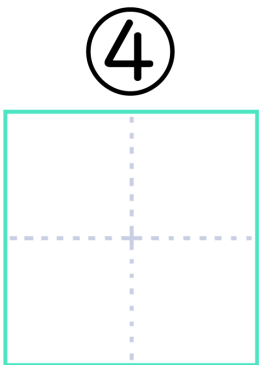

④

げん

因 いん

① 野 の 原

くん
はら

おん
げん

② 高 こう 原

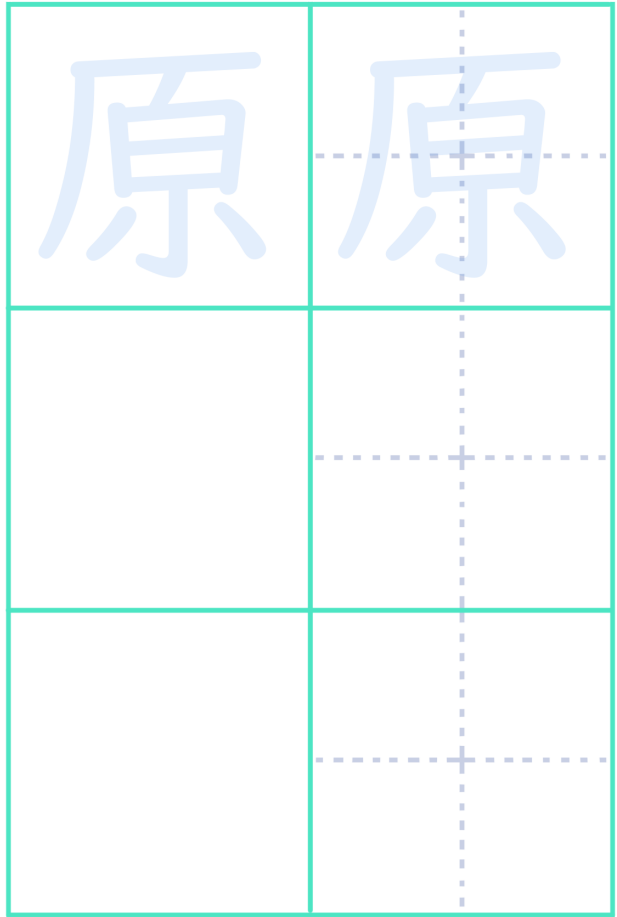

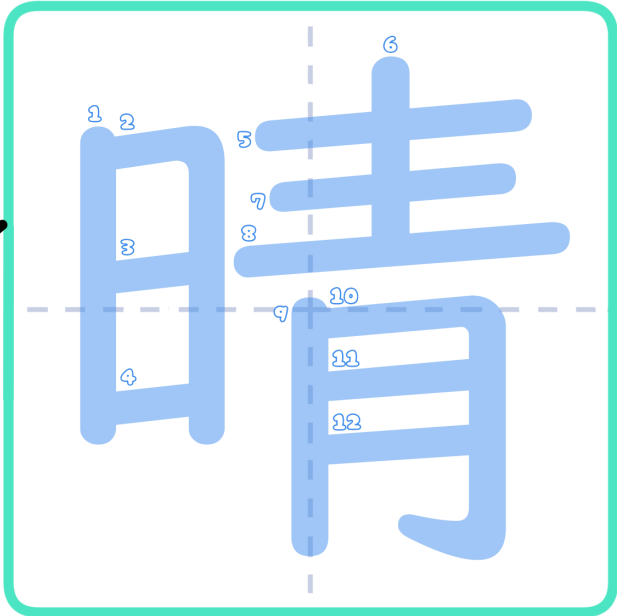
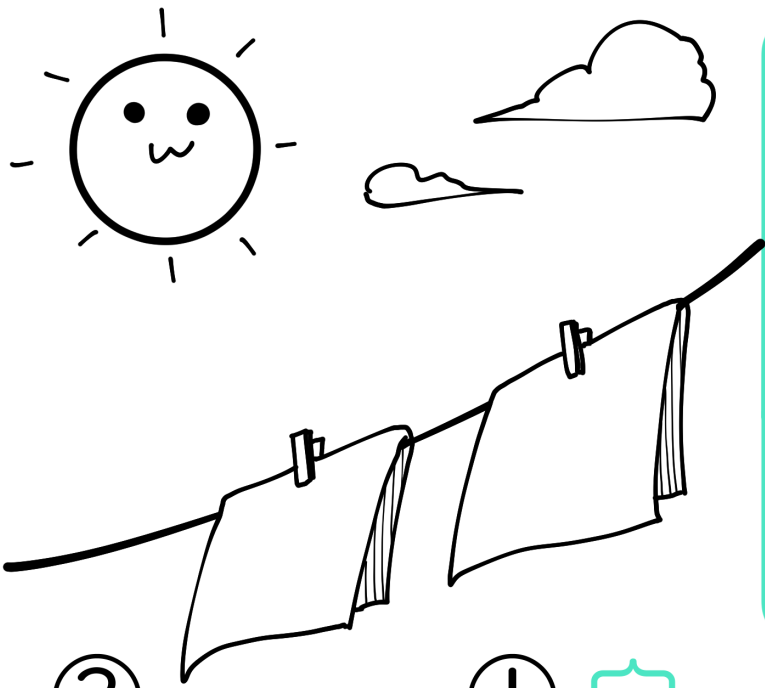

③

せい

天 てん

① 晴 はれた れた す空 そら

くん

は は
ら れ
す る

おん

せい

④

は

れ れ着 ぎ

② 見 み晴 はらし

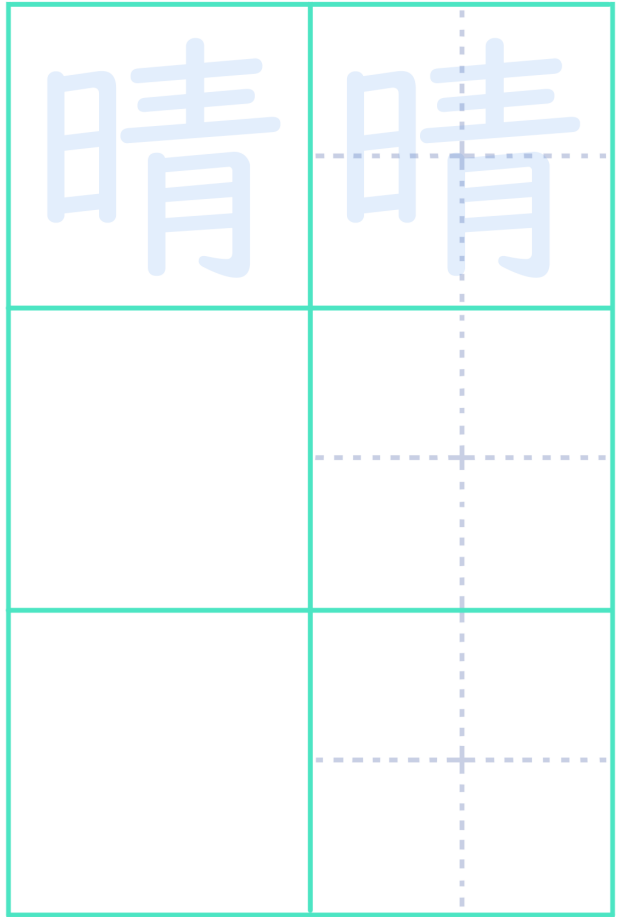

かんじプリント

なまえ

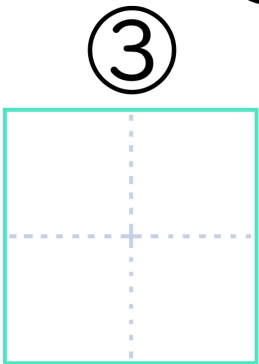
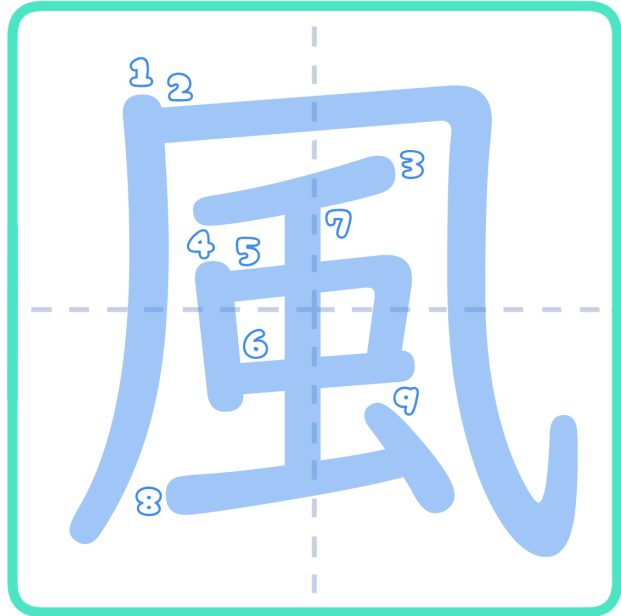
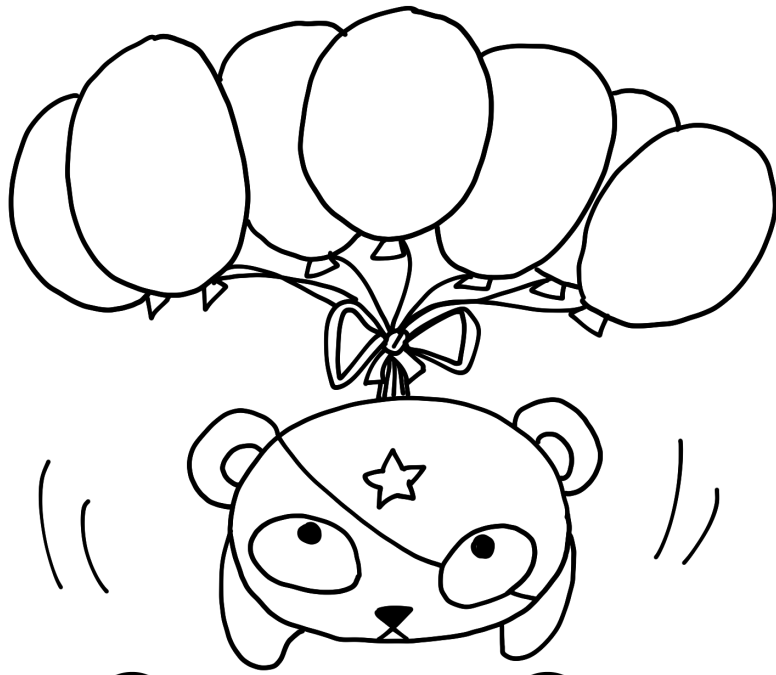

ふう

船 せん

① 風 かぜ が 吹 ふ く

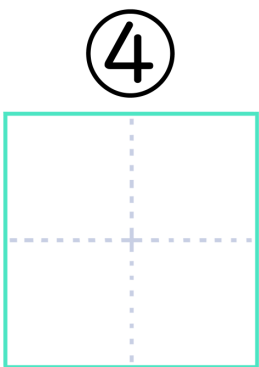

かぜ

向 む き

② 風 かぜ 車 ぐるま

くん
か か
ざ ぜ

おん
（ ふう
） う

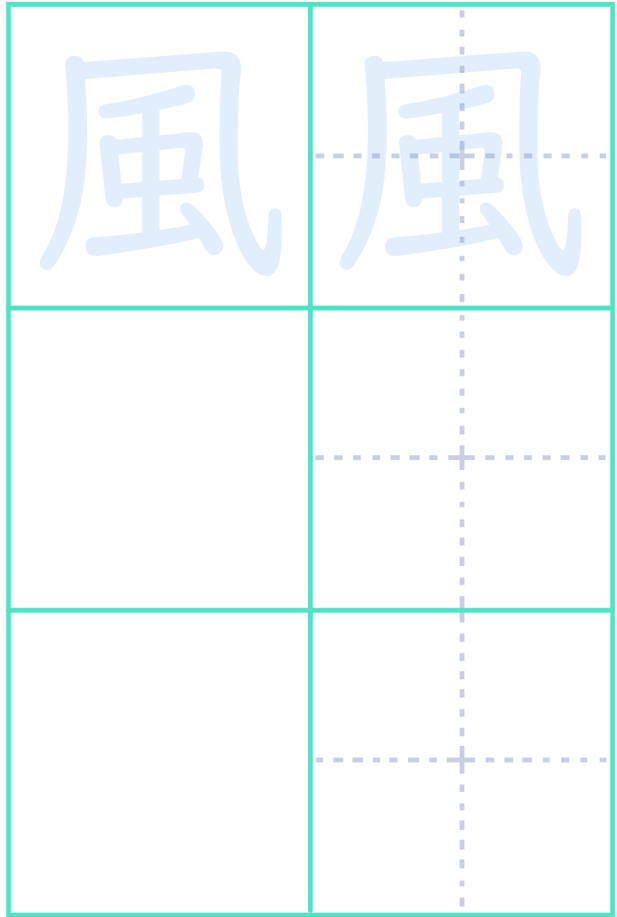

かんじプリント

なまえ

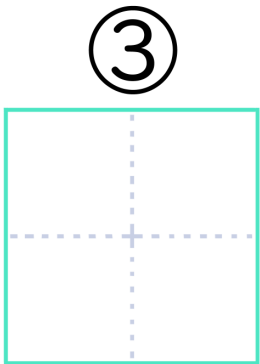
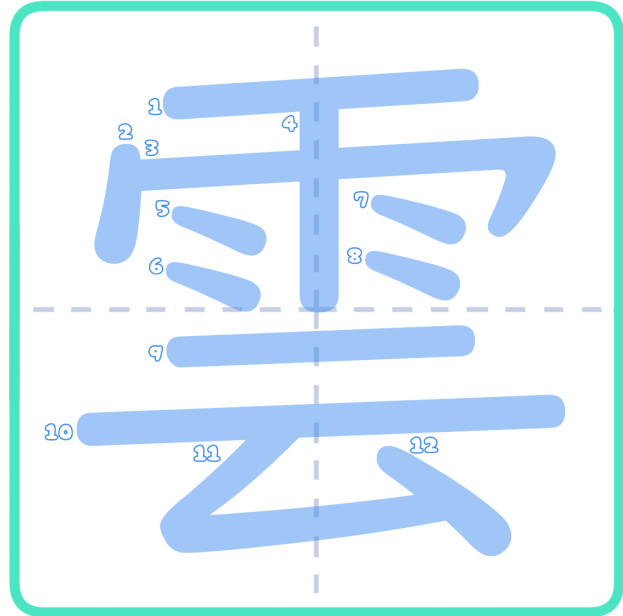

うん

海^{かい}

① 白^{しろ}
い
雲

くん
く
も

おん
う
ん

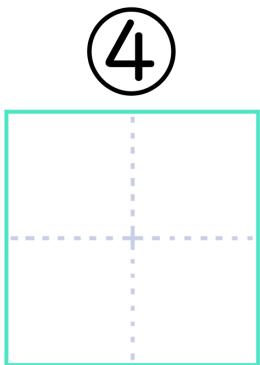

くも

② 星^{せい}
雲

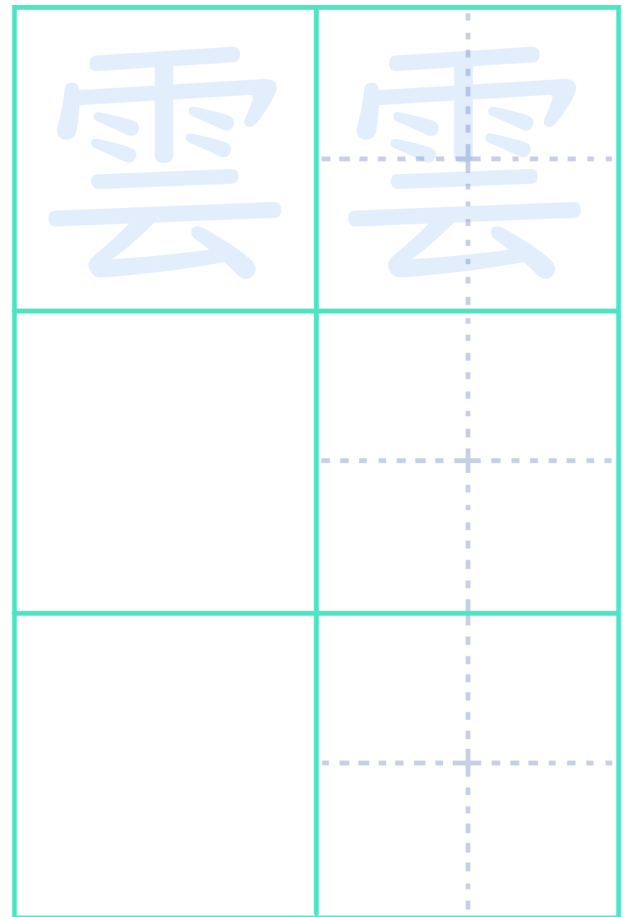

かんじプリント

なまえ

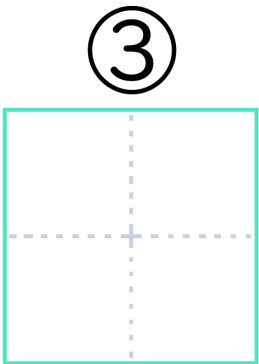
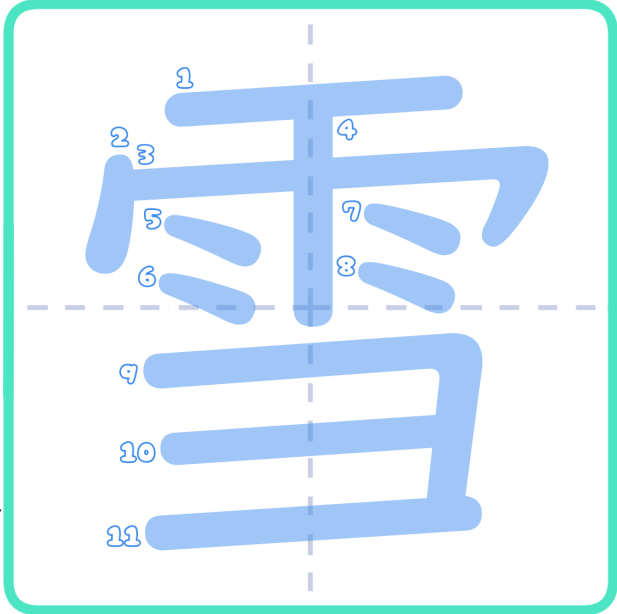

③ 国 くに

ゆき

① 雪 ゆき だるま

くん
ゆき

おん
せつ

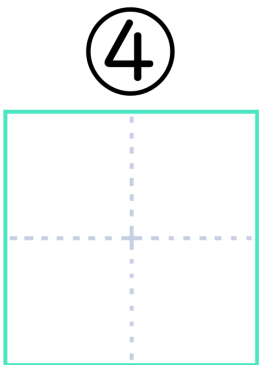

④ 原 げん

せつ

② 風 ふう 雪 ゆき

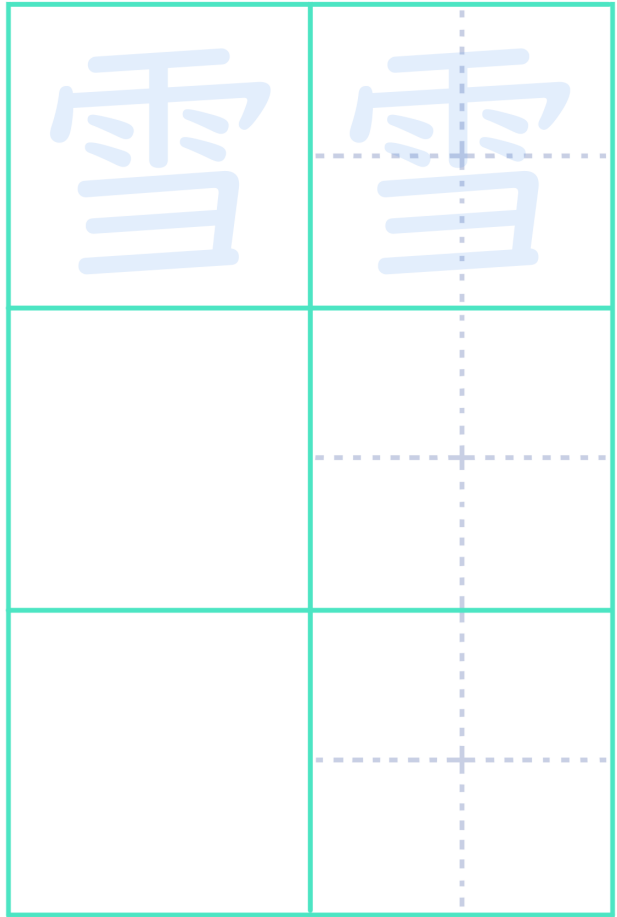

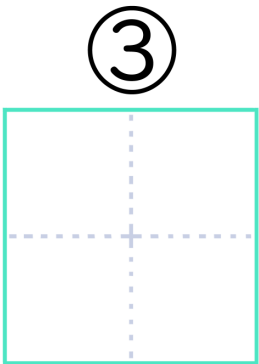
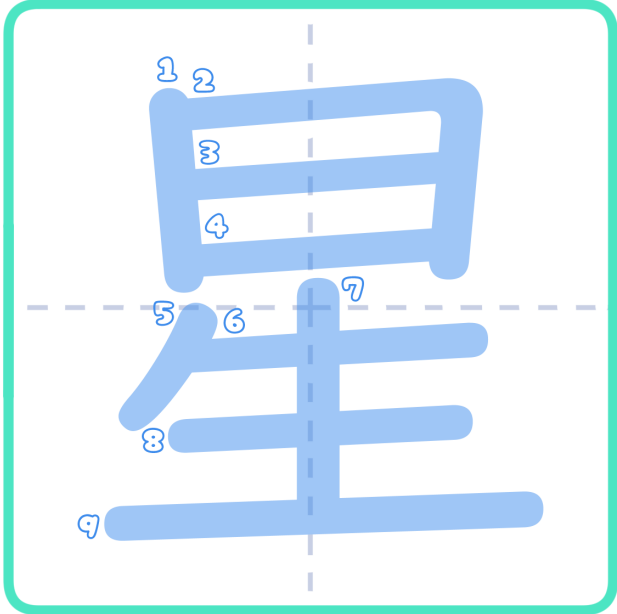
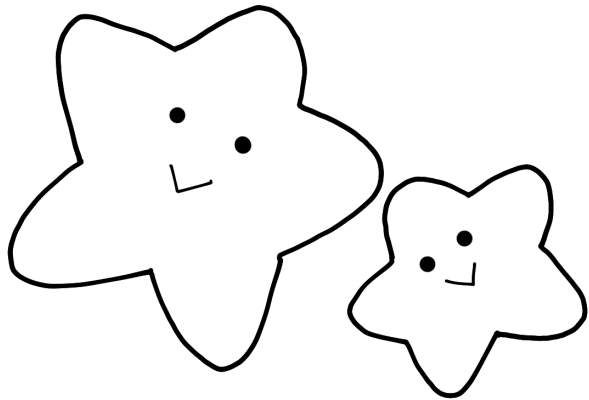

ほし

形 がた

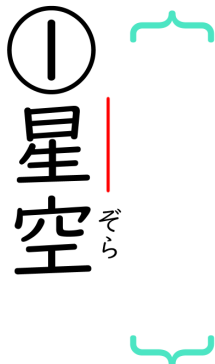

くん
ほし

おん
せい
(しょう)

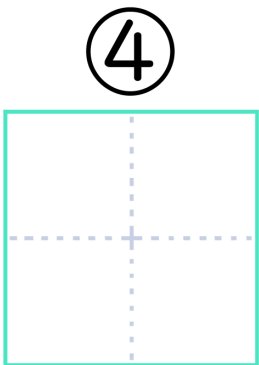

せい

座 ざ

