

かんじプリント

なまえ

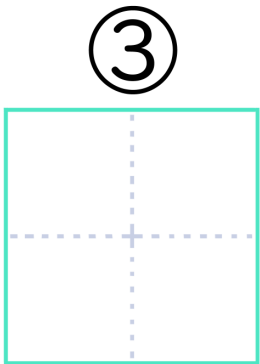
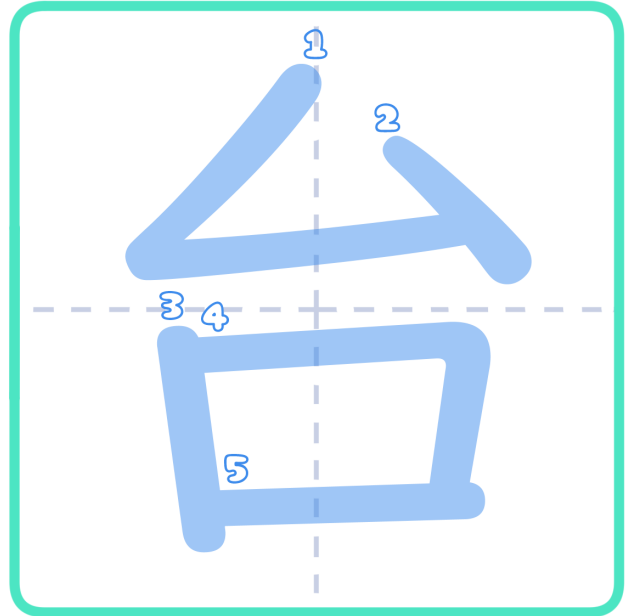

風ふう

たい

① 土ど
台

くん

おん

ただ
いい

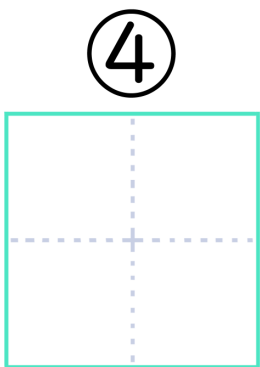

所ところ

だい

② 屋や
台

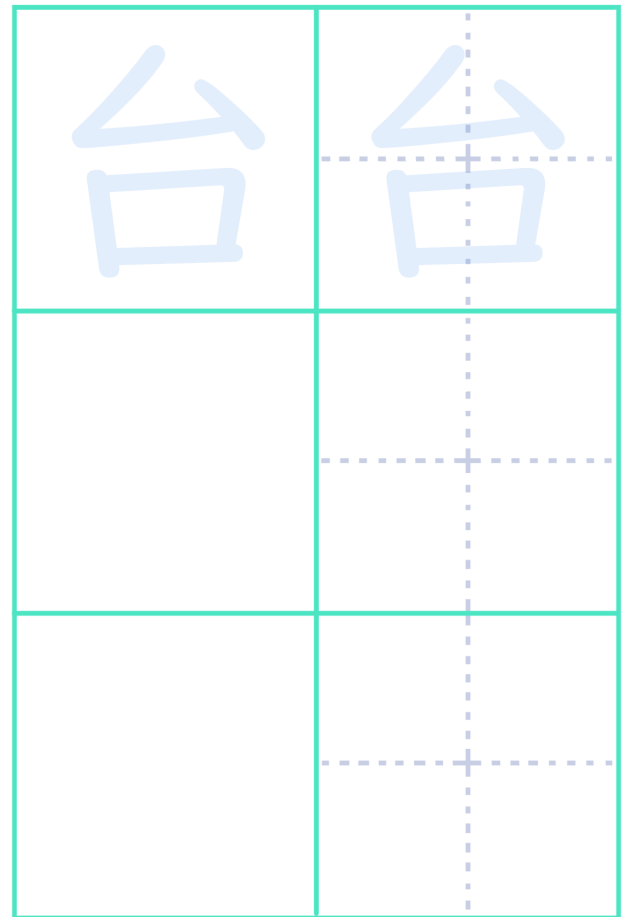

かんじプリント

なまえ

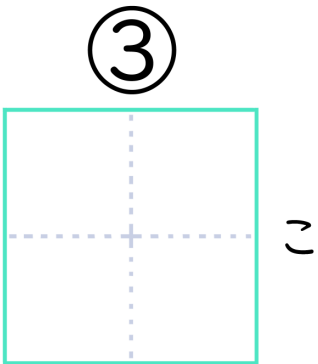
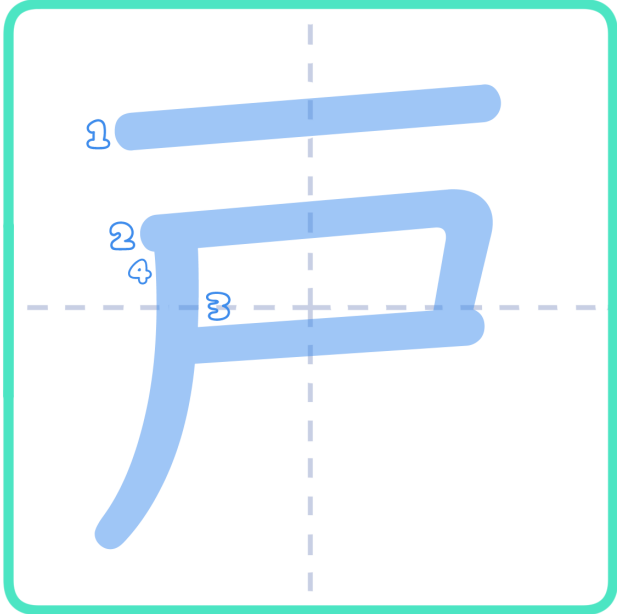

建^だ
て

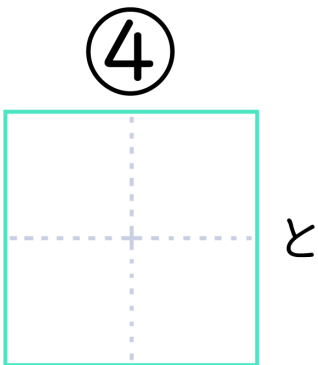

締^じ
まり

くん
と

おん
こ

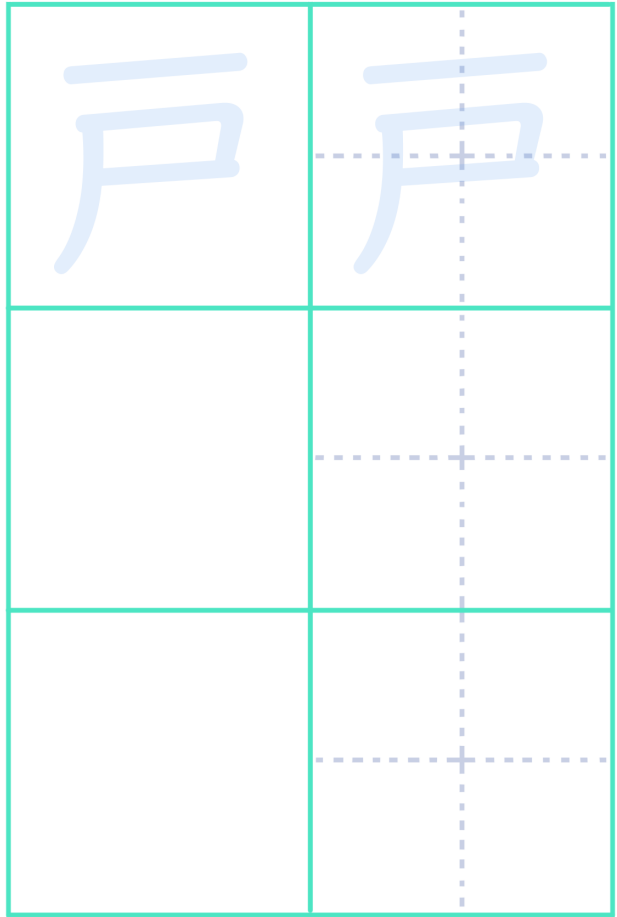

かんじプリント

なまえ

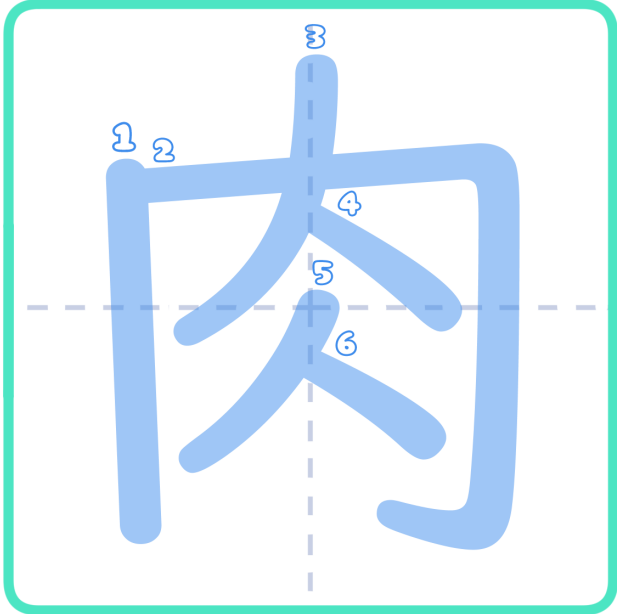
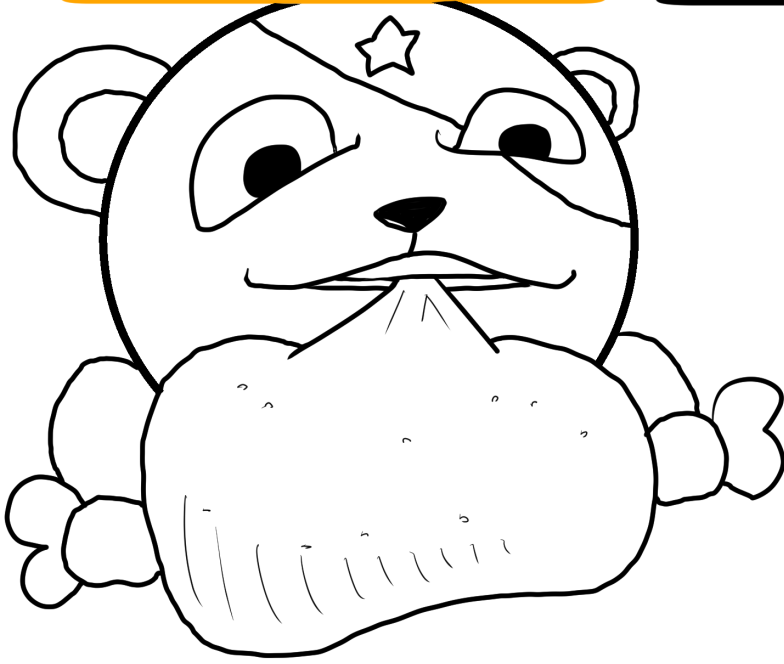

くん

おん

にく

③

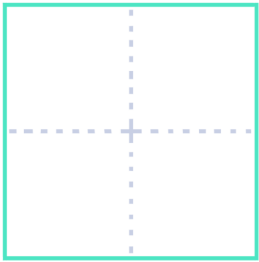

にく

体たい

①

焼やき肉



④

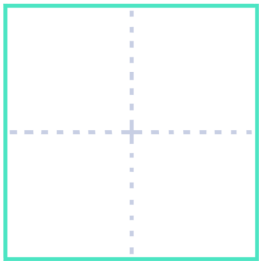

にく

食しょく

②

筋きん肉

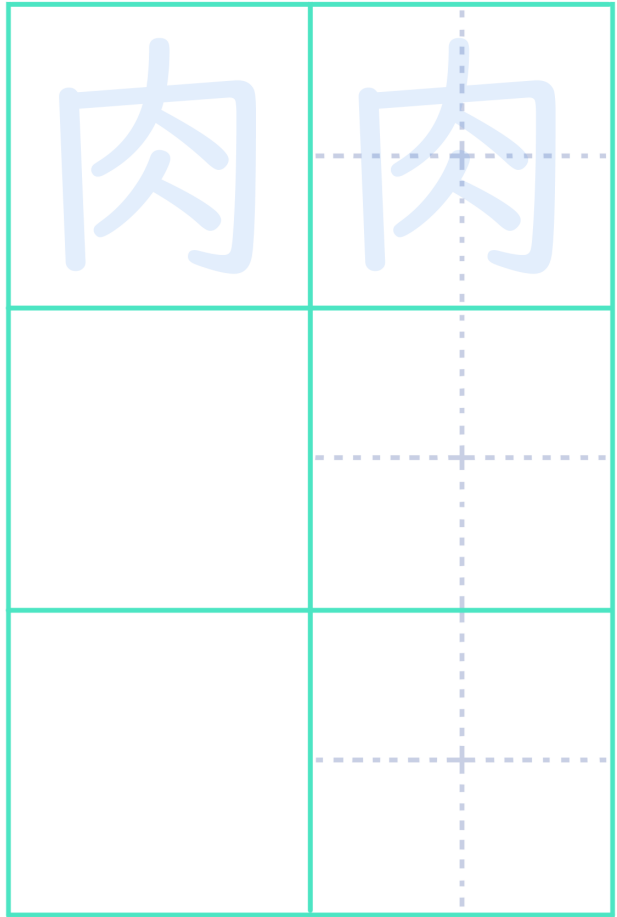

かんじプリント

なまえ

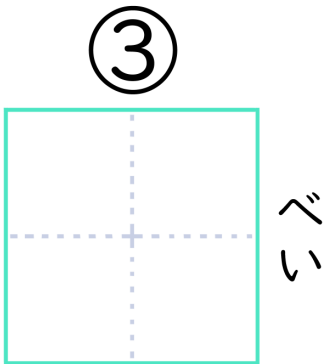
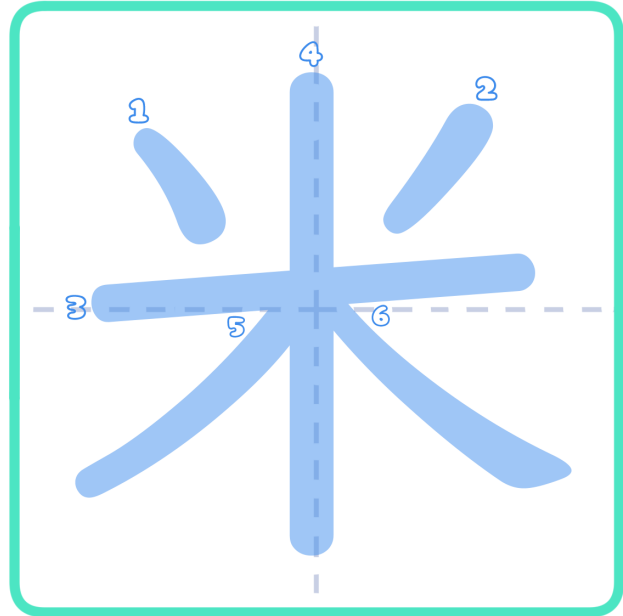
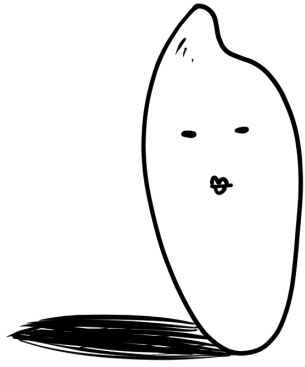

作つく

① お米

くん
こめ

おん
まげ
いい

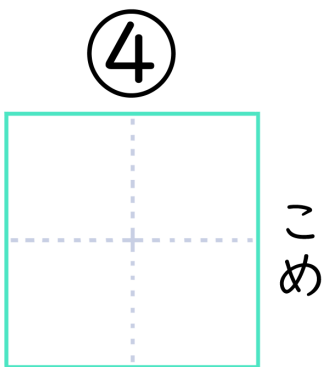

粒つぶ

② 新米

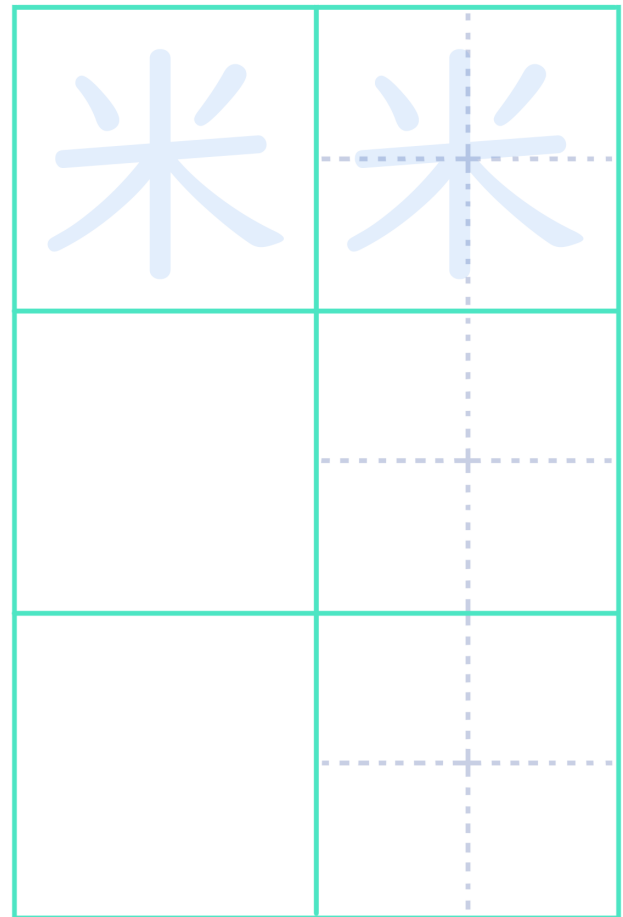

かんじプリント

なまえ

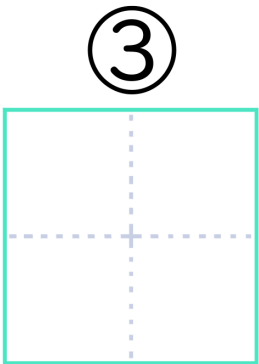
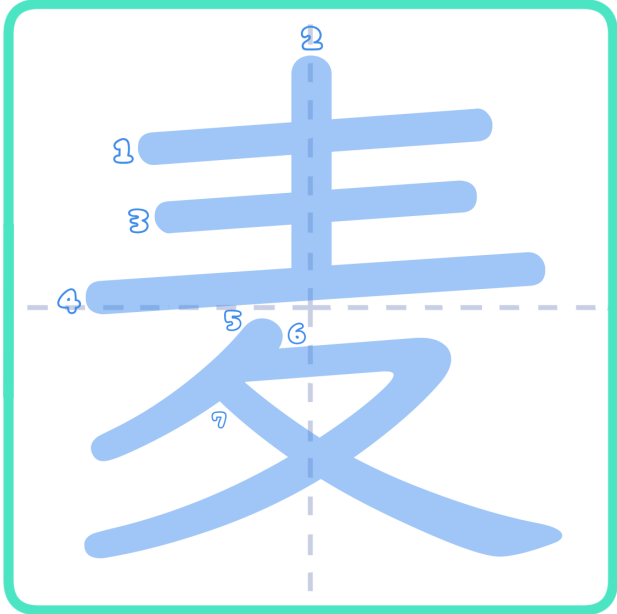
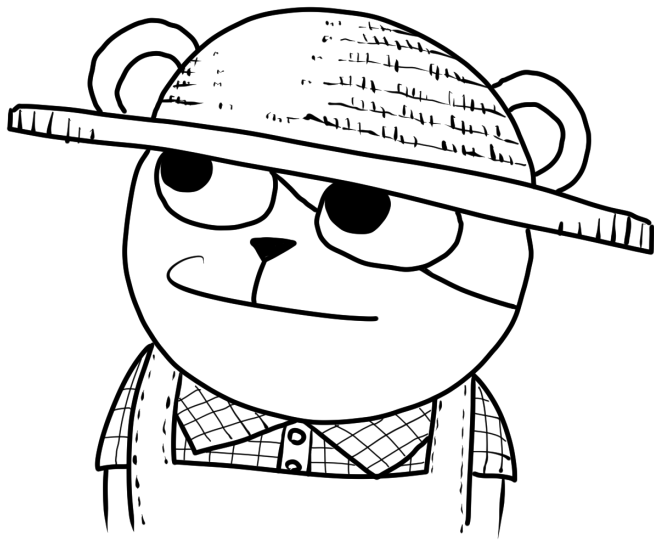

畑 ばたけ

むぎ

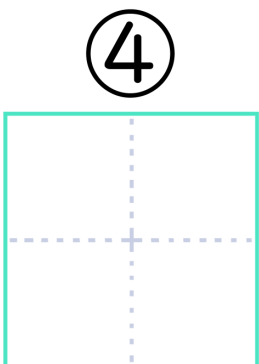
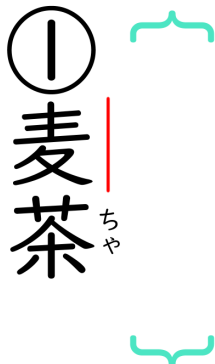

わら帽子 ぼうし

むぎ

くん
むぎ

おん
(ばく)

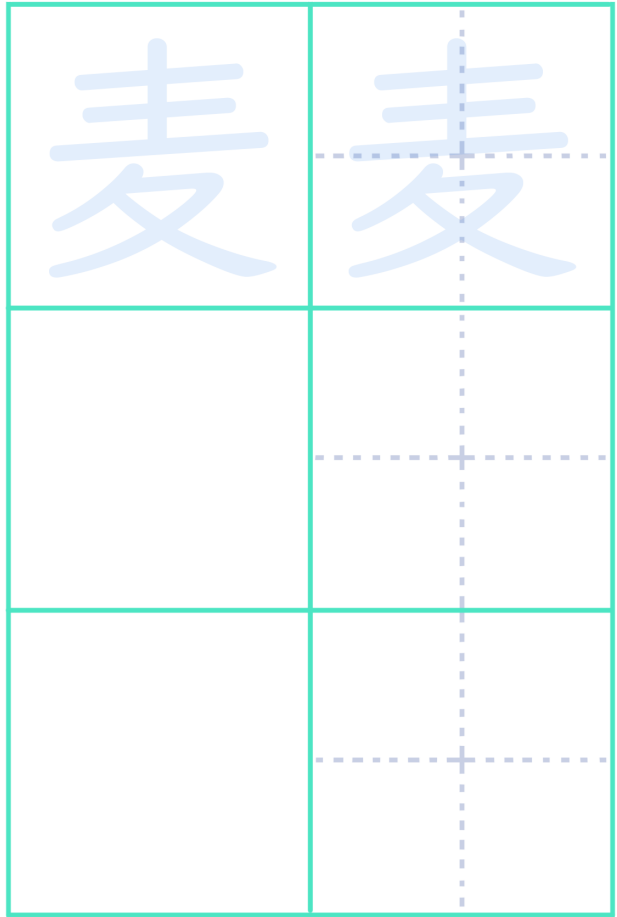

かんじプリント

なまえ

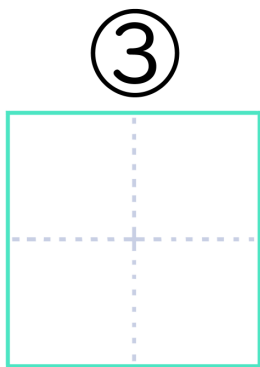
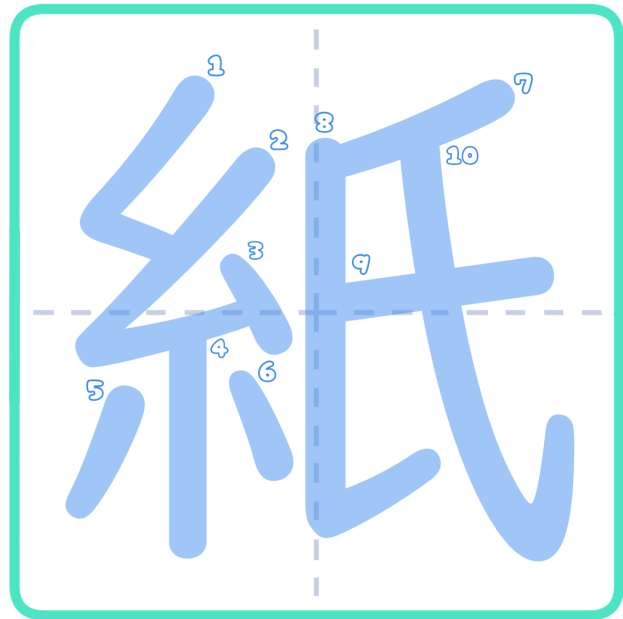
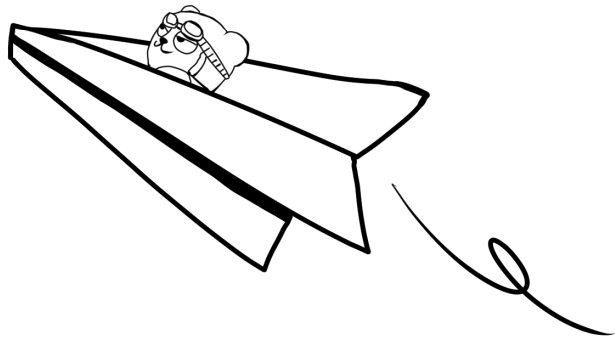

かみ

くず

① 表紙 ひょうし

くん
かみ

おん
し

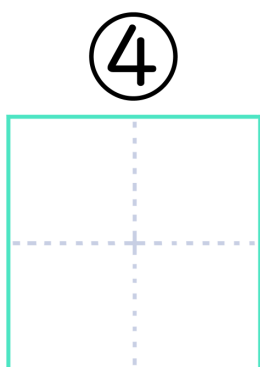

かみ

飛行機 ひこうき

② 新聞紙 しんぶん

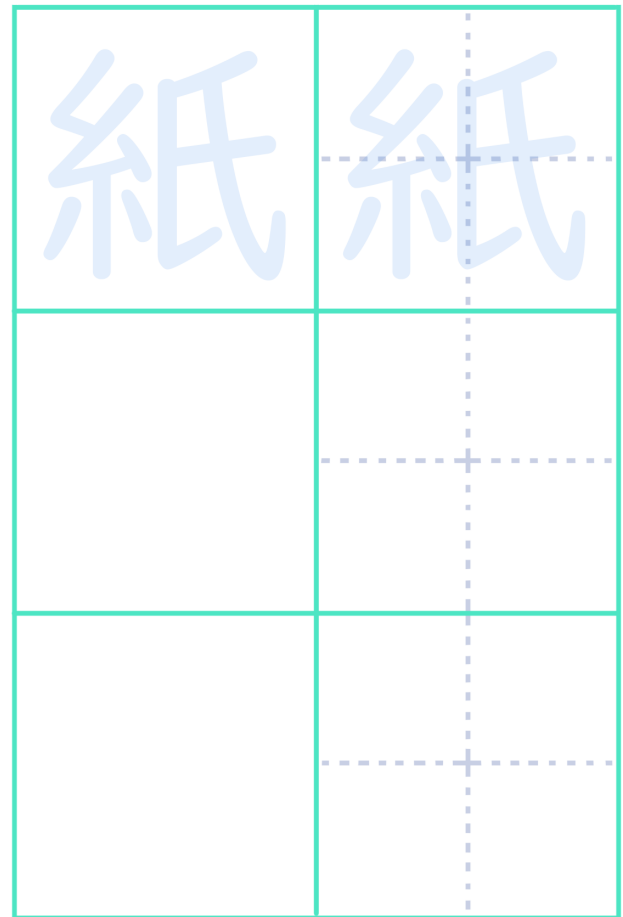

ワザポイント

手紙 てがみ

こんな
読み方も
あるよ♪

かんじプリント

なまえ

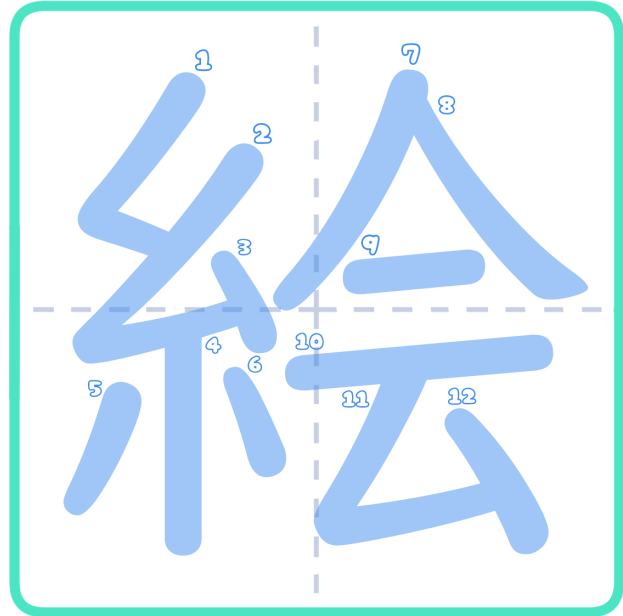
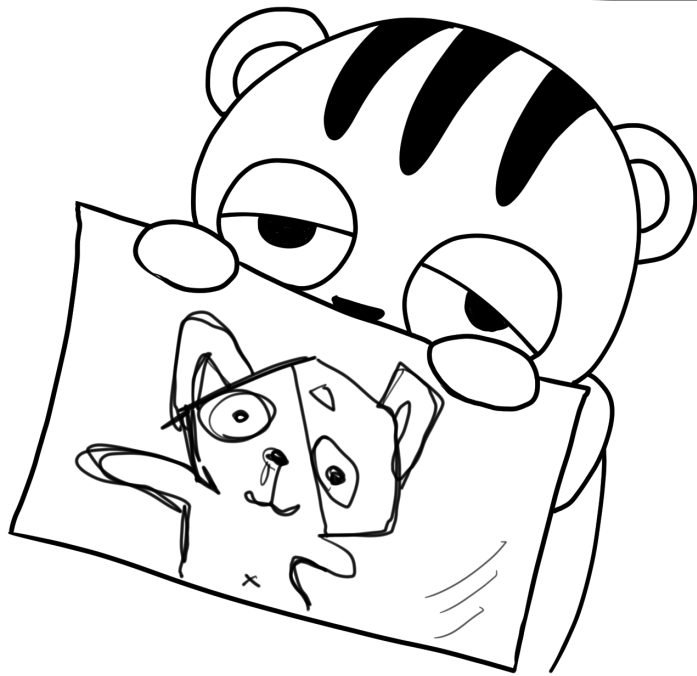

くん

おん

え
かい

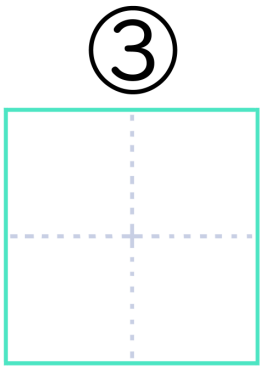

画が

① 絵本ほん

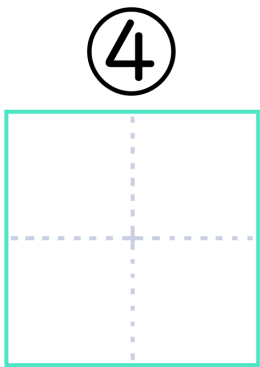

の
具ぐ

② 絵日に記き

