

かんじプリント

なまえ

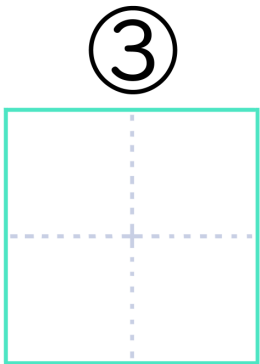
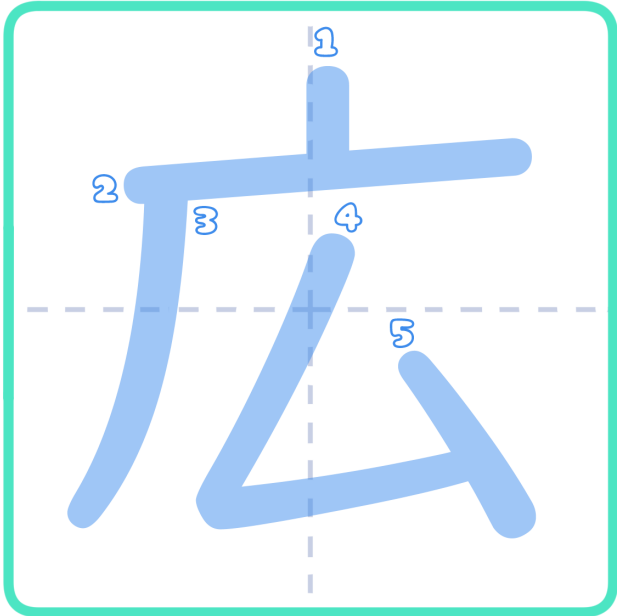

ひろ

い

① 広場 ひろば

くん
ひろ
い

おん
こう

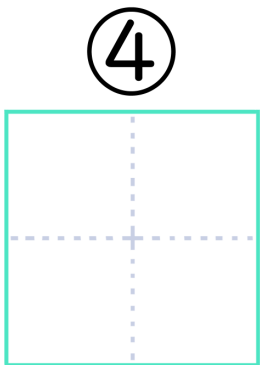

ひろ

める

② 広告 こうこく

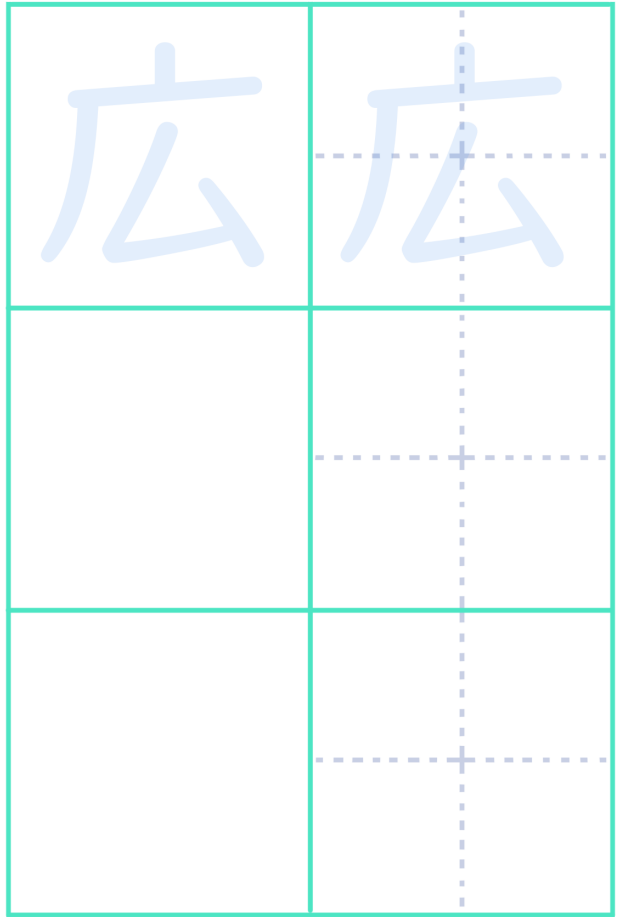

かんじプリント

なまえ

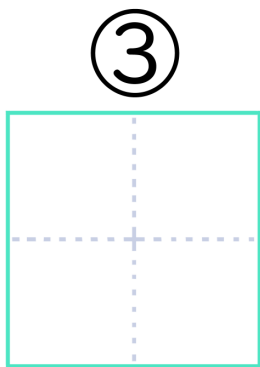
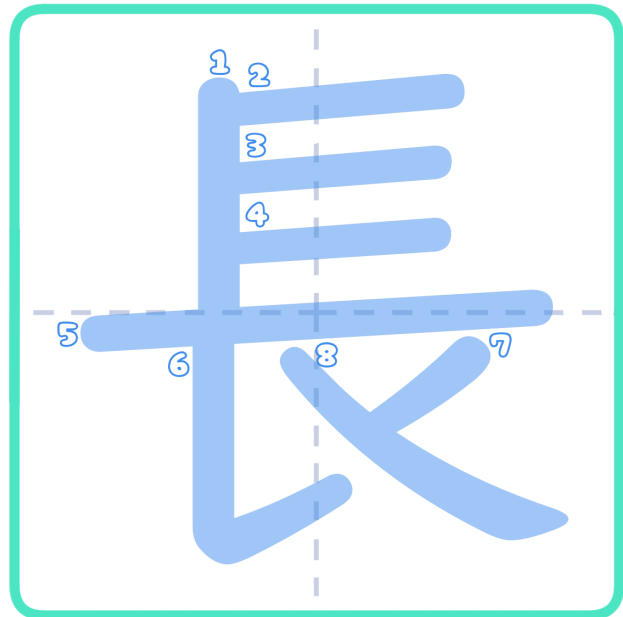
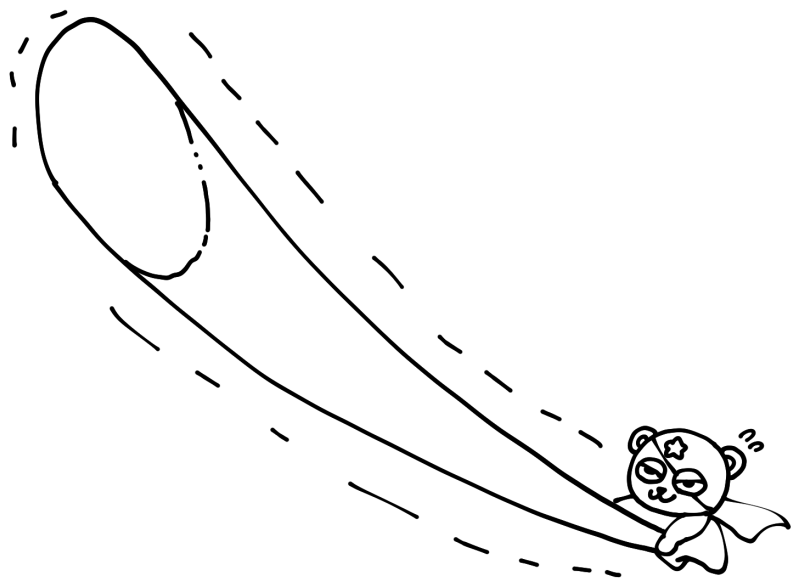

ちよう

方
形

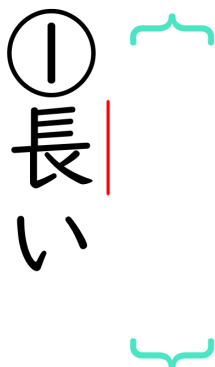

くん
なが
い

おん
ち
よう

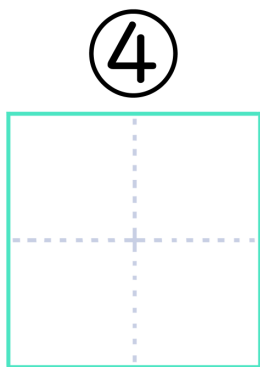

なが

い
廊
下

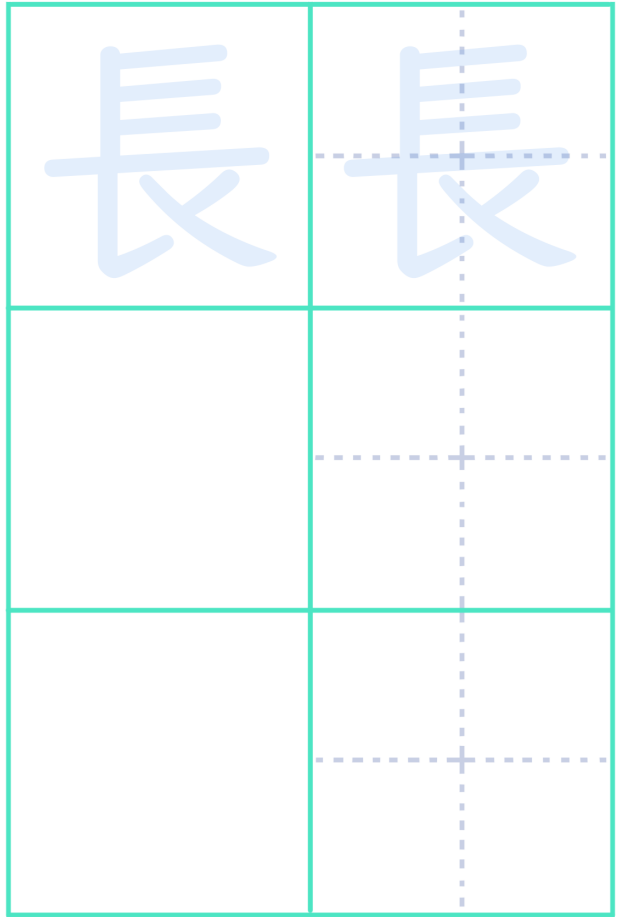

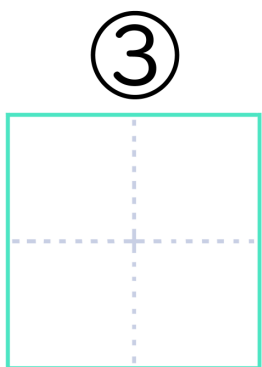
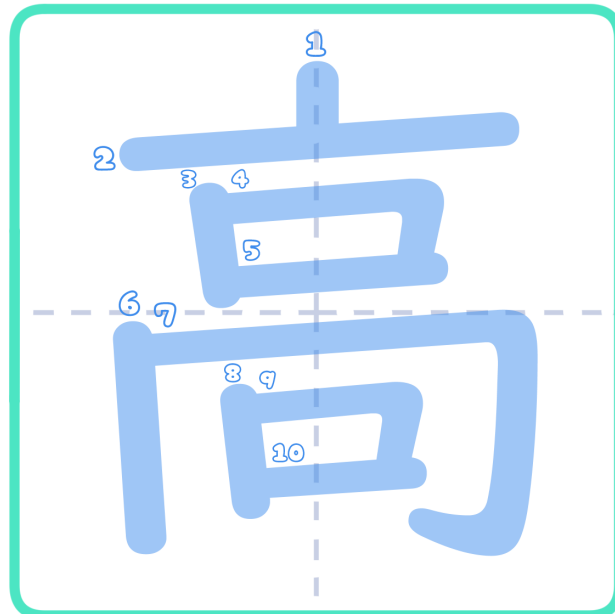

音 おん

こう

① 高い山 やま

くん
た
か
い

おん
こ
う

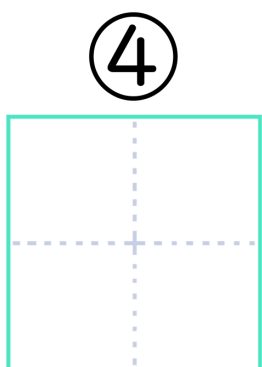

台 だい

た
か

② 高原 げん



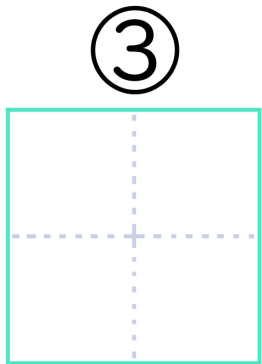
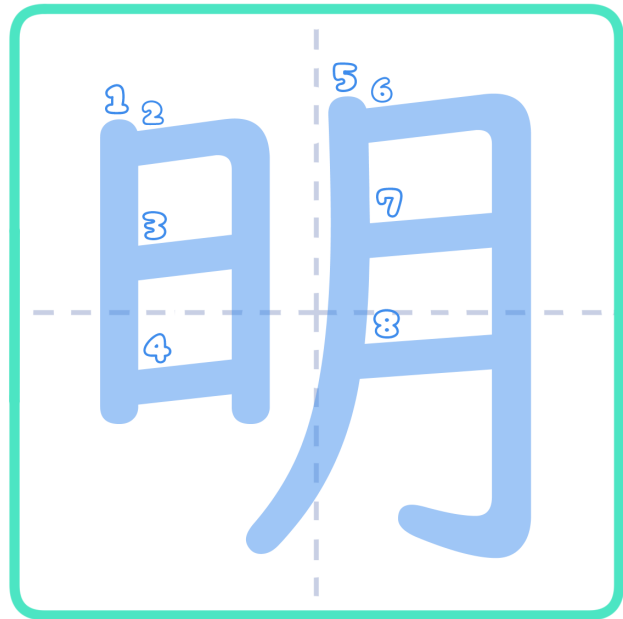

③

あか

る
い

①

発^{はつ}
明

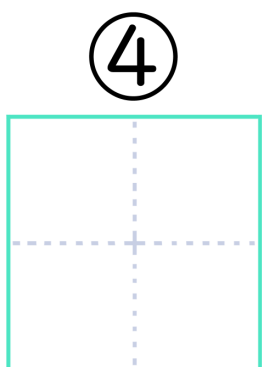

④

みよう

朝^{ちよう}

②

夜^よ
明
け

くん

おん

あ あ あ あ
け き か か
る ら る り
か い

み め
よ い
う

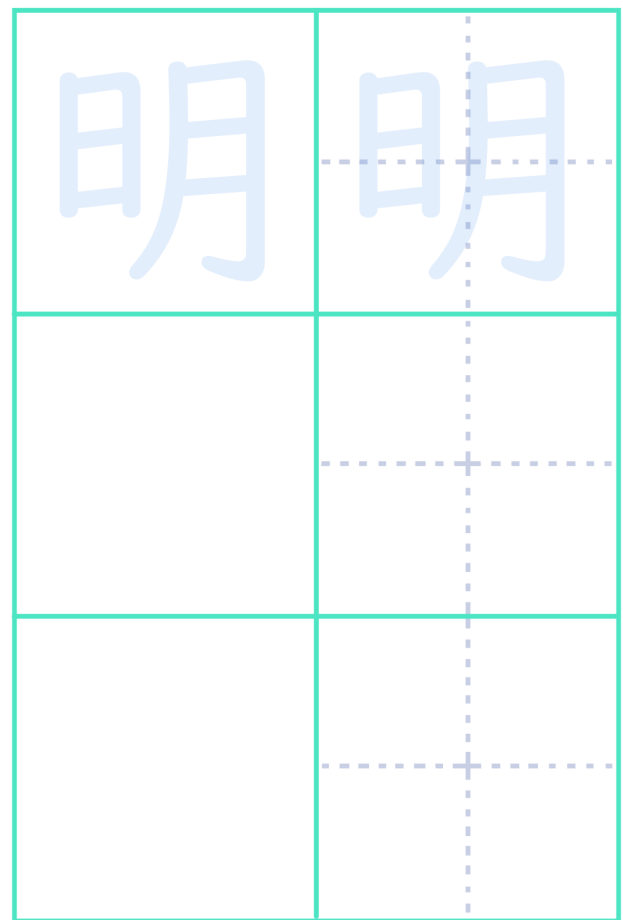

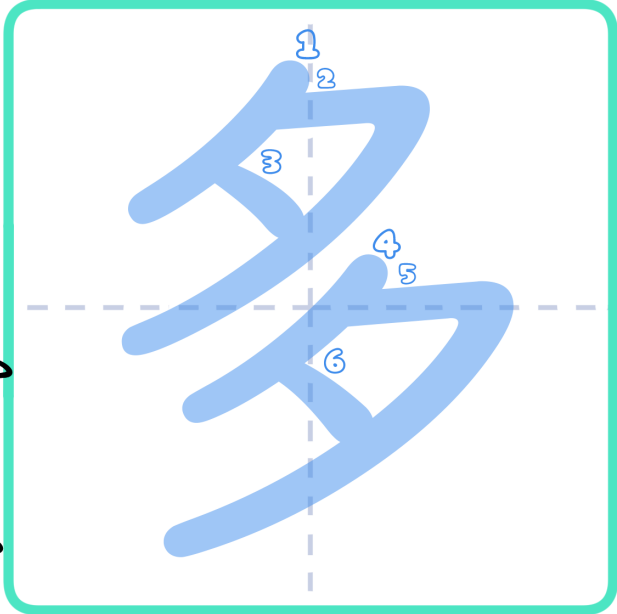
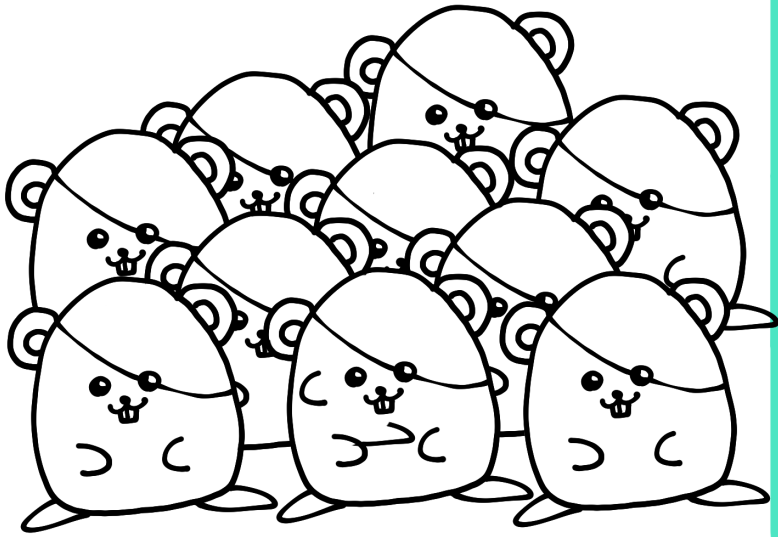

③

た

少 しょう

①

多 た

い

くん

お

お

い

おん

た

④

た

発 はつ

②

多 た

数 すう

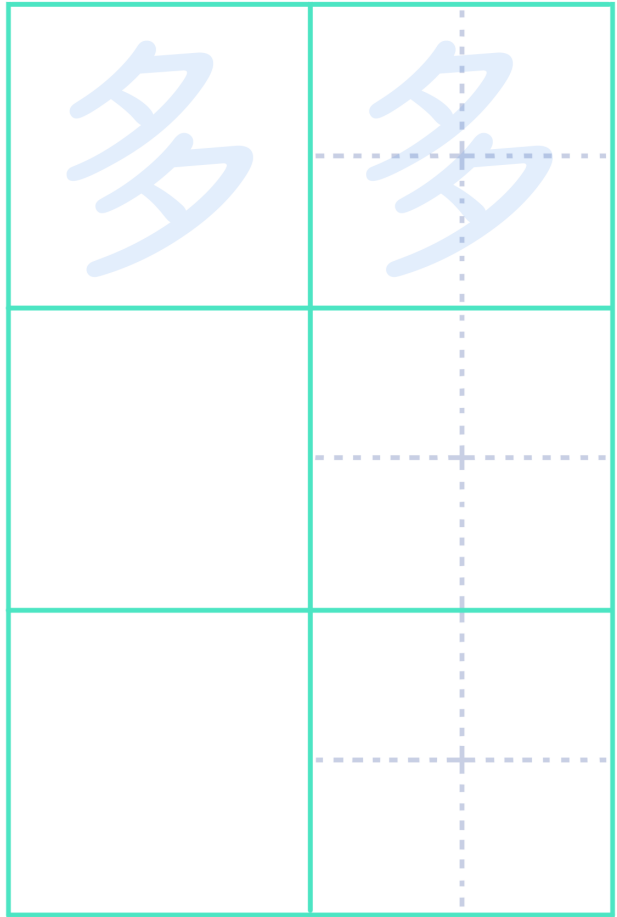

かんじプリント

なまえ

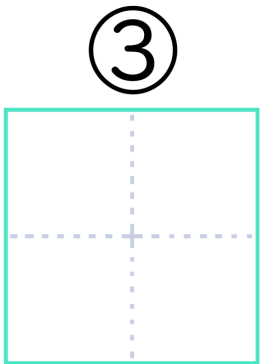
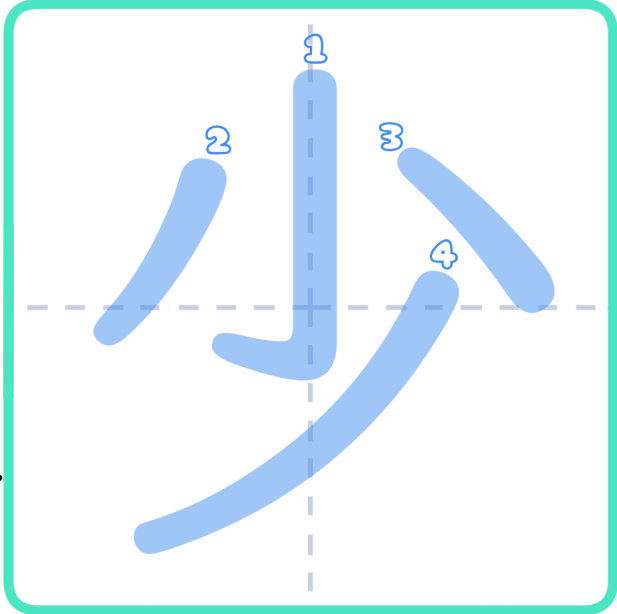
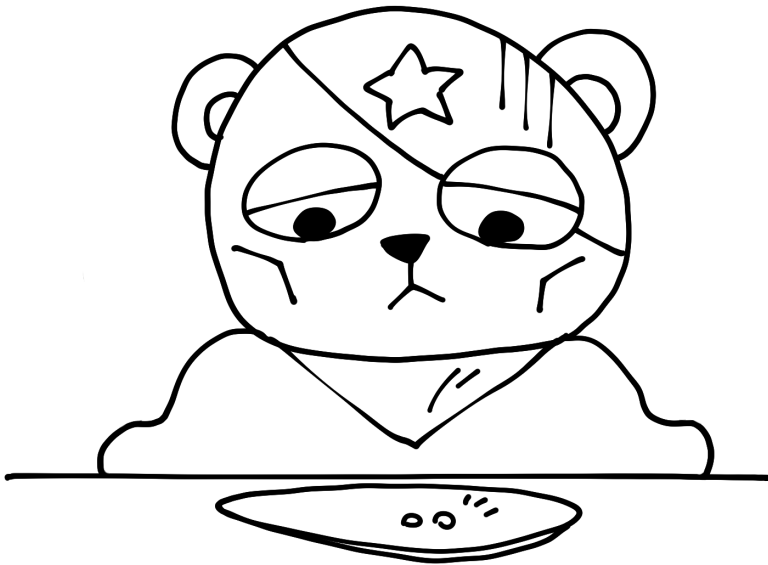

しょう

年 ねん

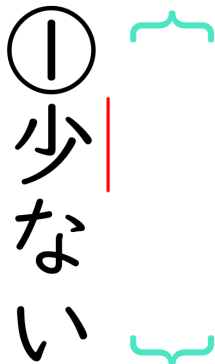

くん
す す
こ く
し ない

おん
し
ょう

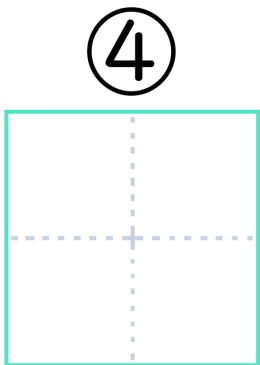

しょう

女 じょ

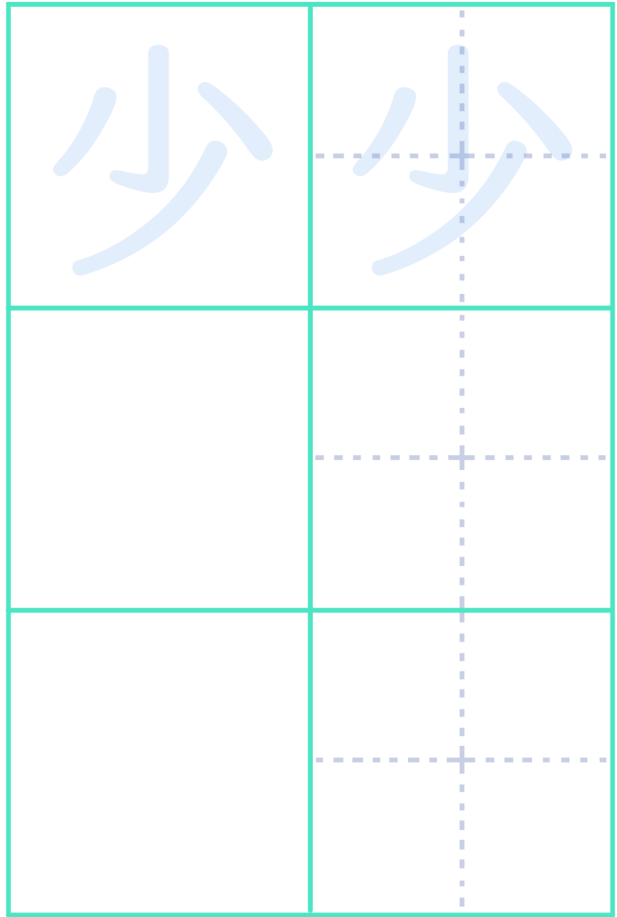
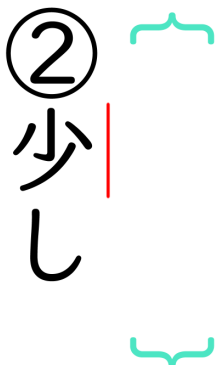

かんじプリント

なまえ

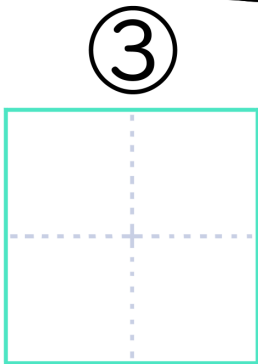
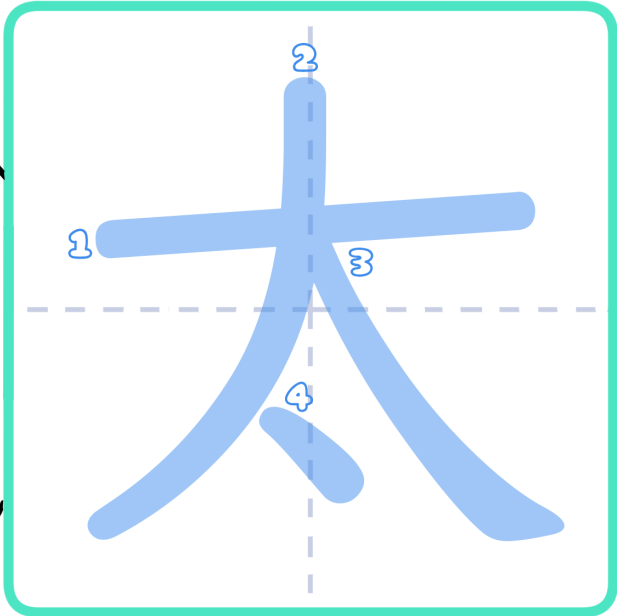
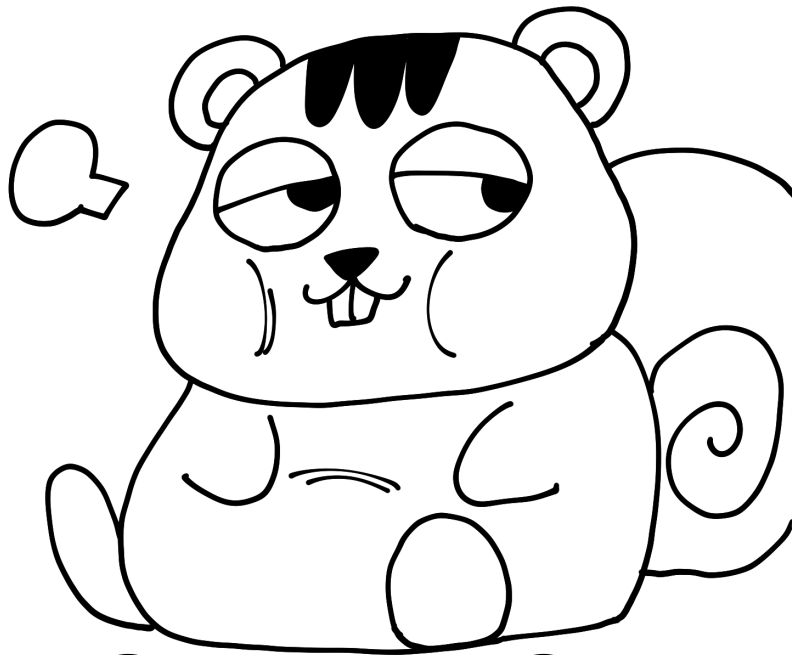

る

ふ
と

① 太陽 よう

くん

ふふ
とと
るい

おん

たた
たい

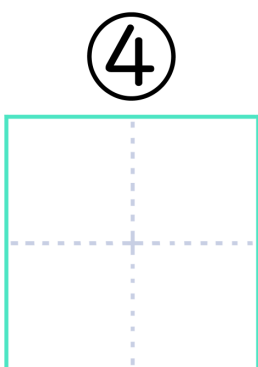

平洋 へい
よう

たい

② 丸太 まる

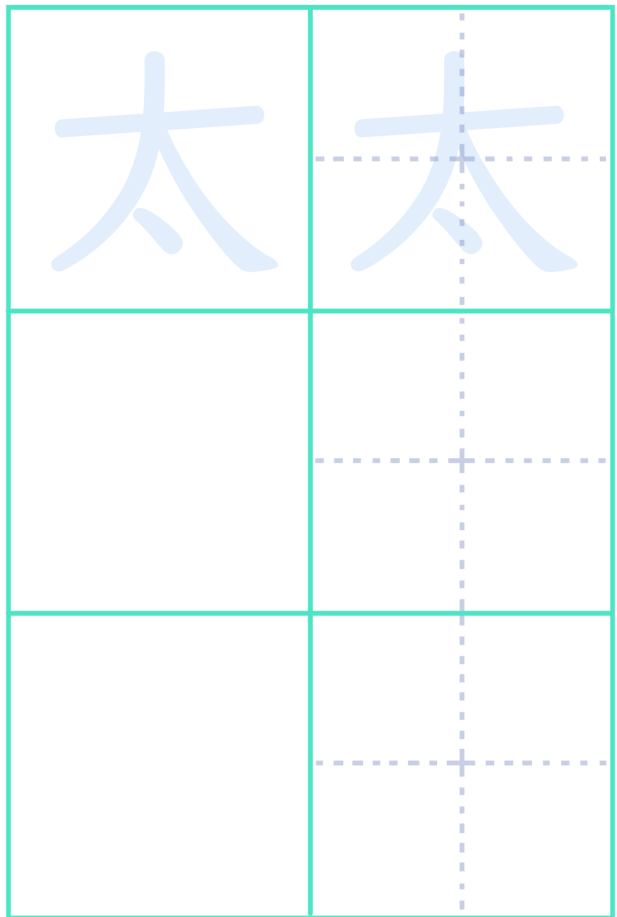

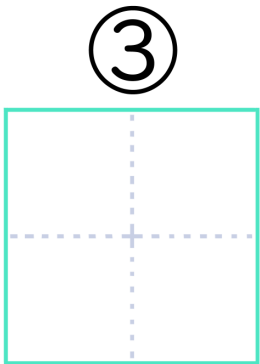
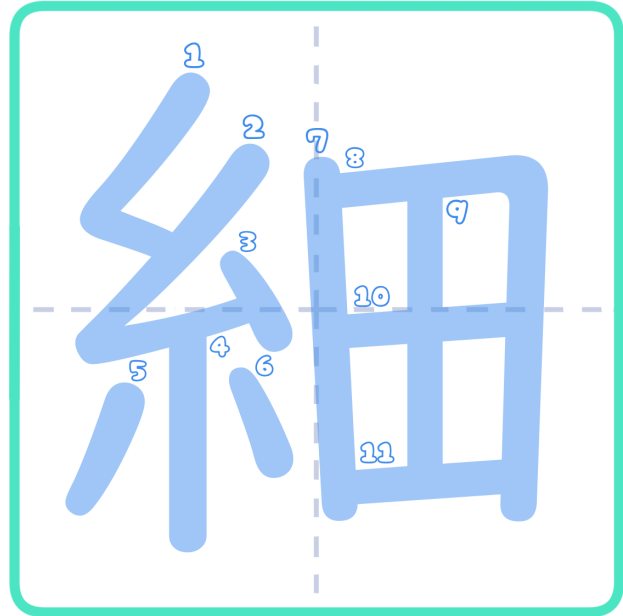

心 しん

① 細 ほそ
かい かい

くん
こほ
まそ
かい
い

おん
さ
い

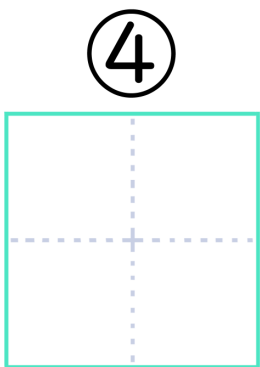

道 みち

② 細 ほそ
工 く

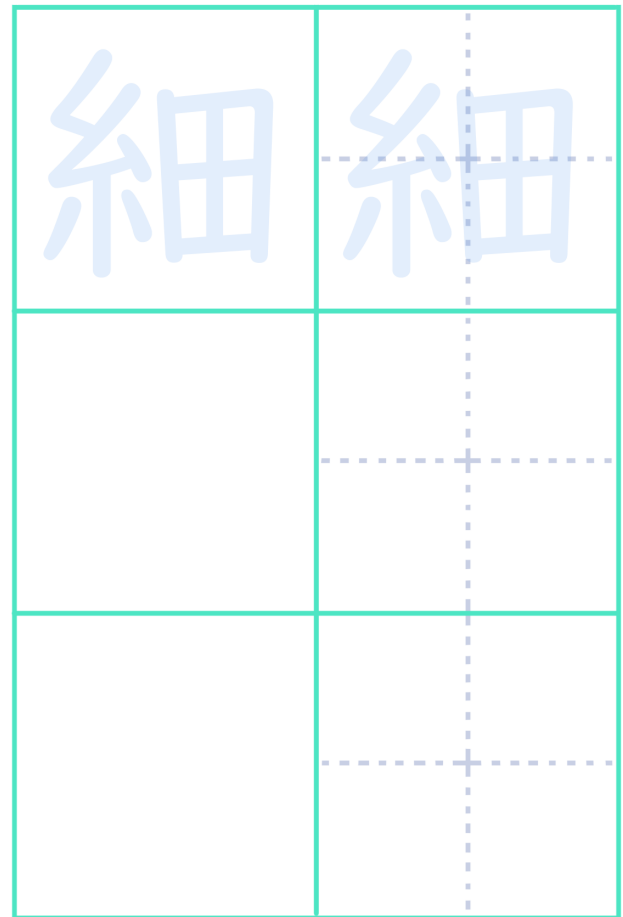

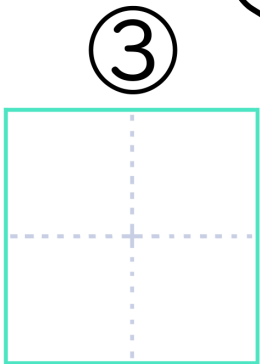
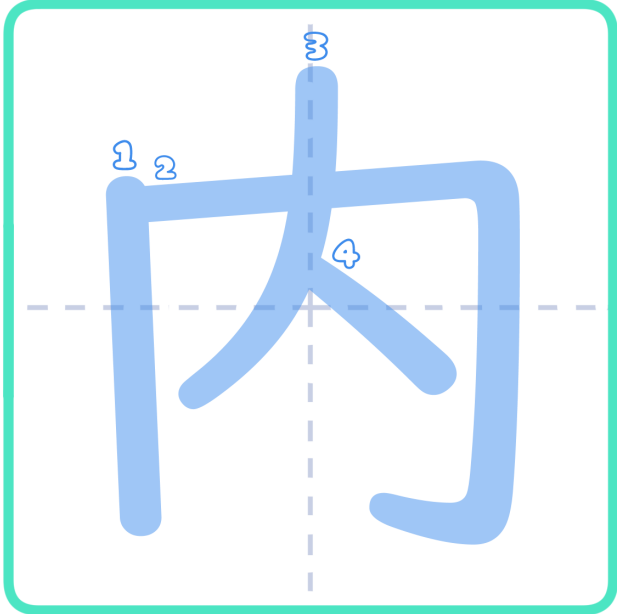
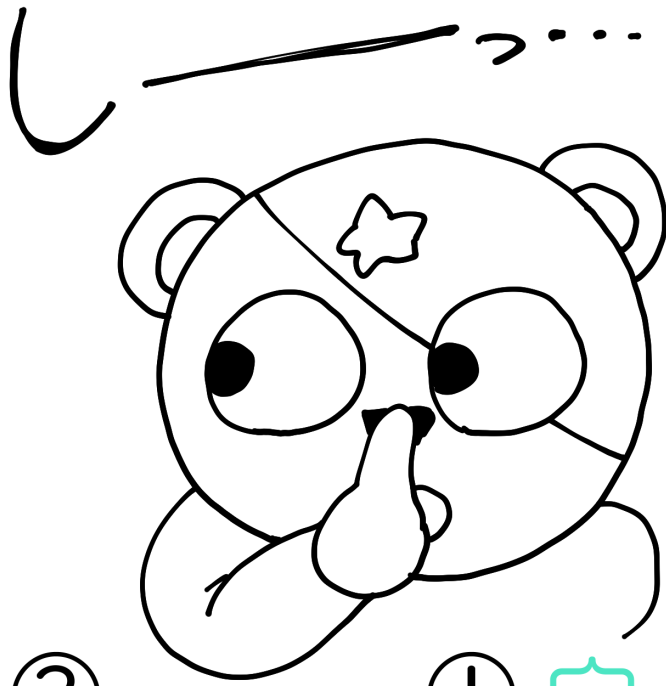

うち

③
気き

① 内側がわ

くん
うち

おん
(ない
だい)

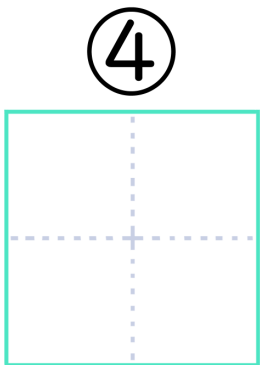

ない

④
緒しよ

② 校内こう

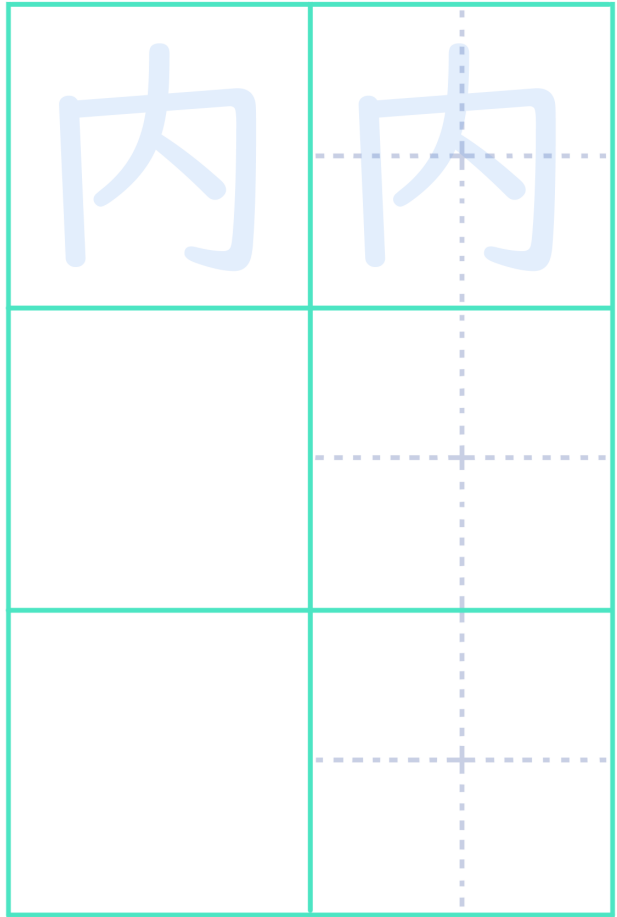

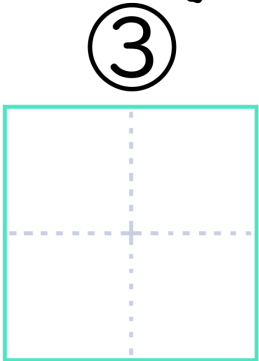
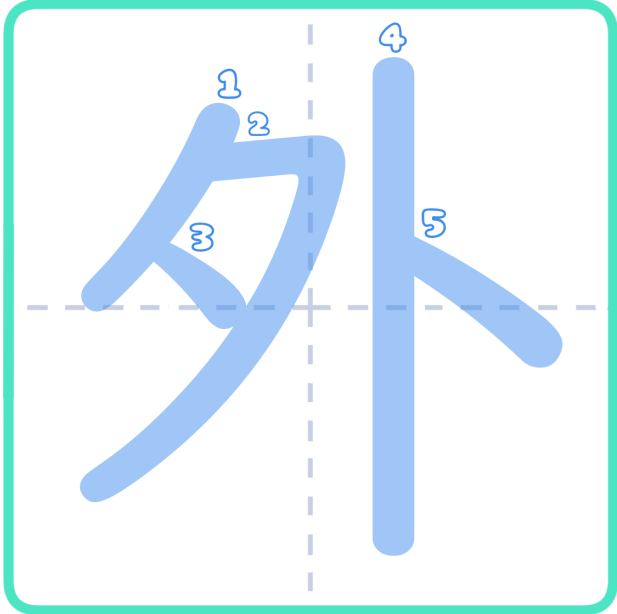

す

はず

① 外側 がわ

くん おん
 ははほそ (げ)がい
 はずずかと
 れす
 る

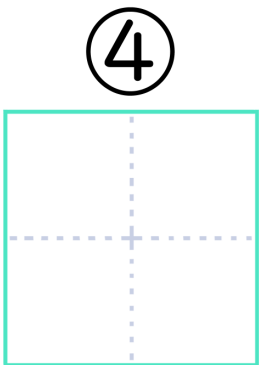

出 で

がい

② 外国 こく

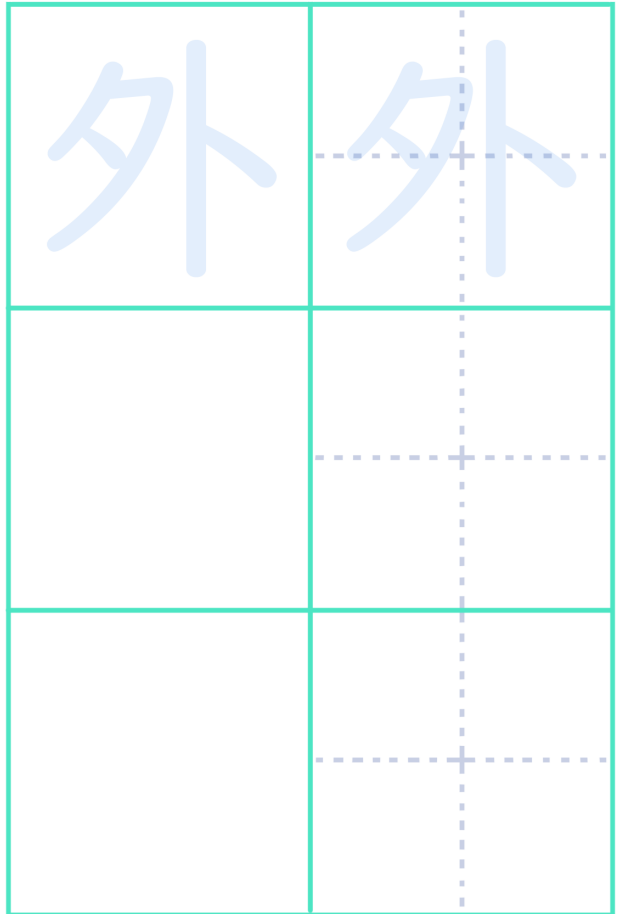

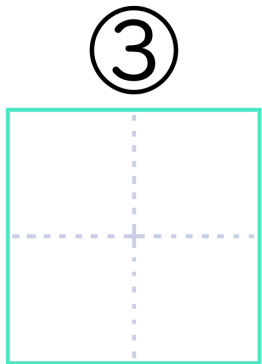
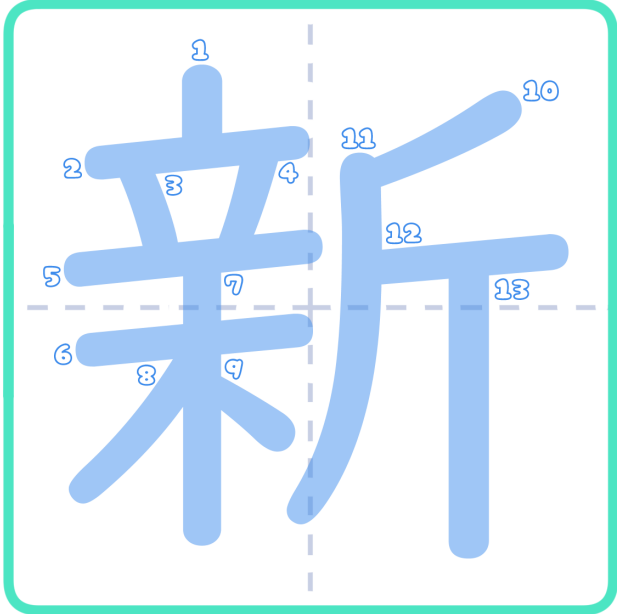

あら

た

① 新聞紙
ぶん し

くん

(にい)
あら
た

おん

しん

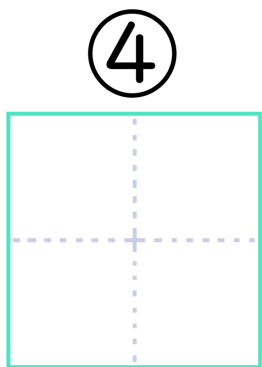

しん

年
ねん

② 新
し
い

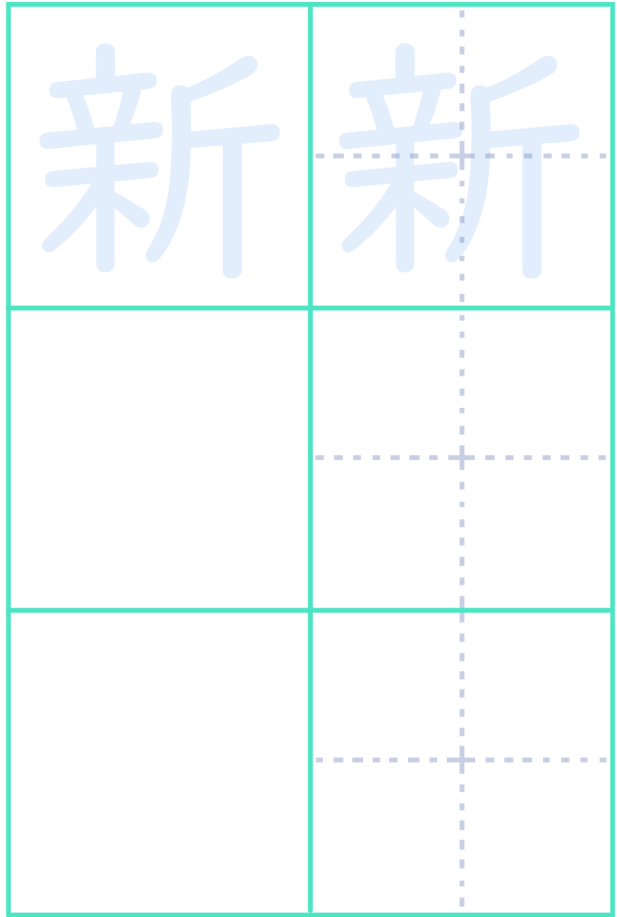

ポイント

新 潟
にいがた

こんな
読み方も
あるよ



かんじプリント

なまえ

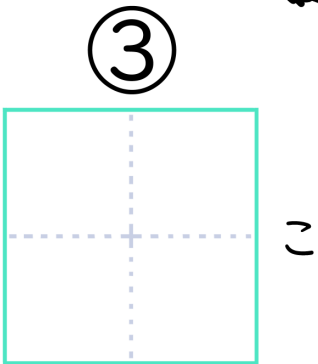
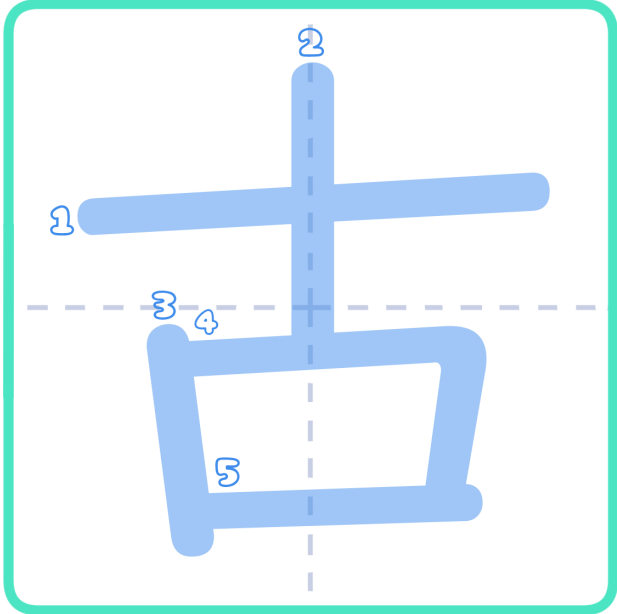

代だい

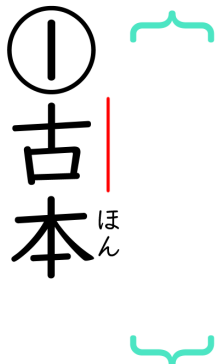

くん
ふる
る
すい

おん
こ

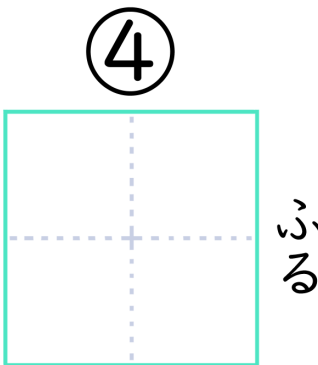

着ぎ

