

かんじプリント

なまえ

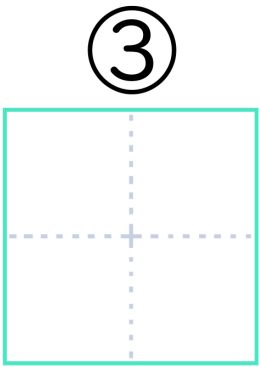
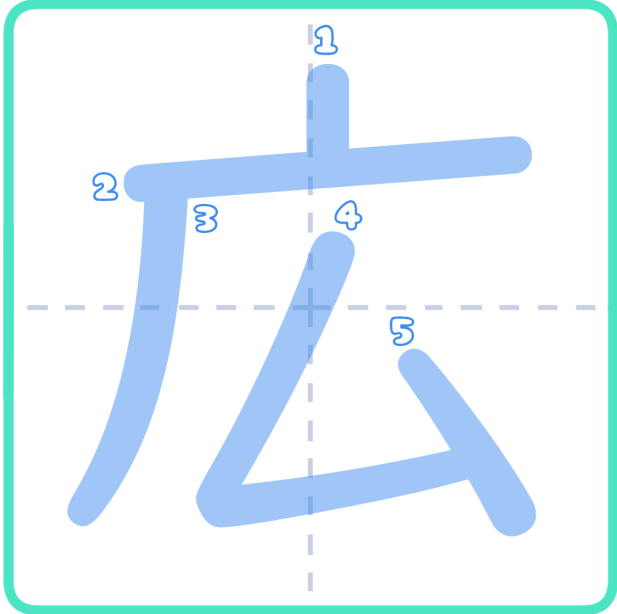

ひろ

い

① 広場 ひろば

くん
ひろ
い

おん
こう

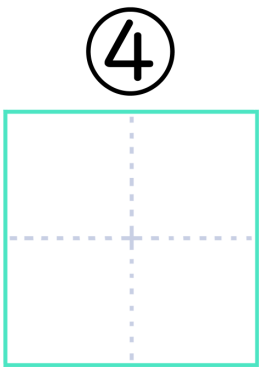

ひろ

める

② 広告 こうこく

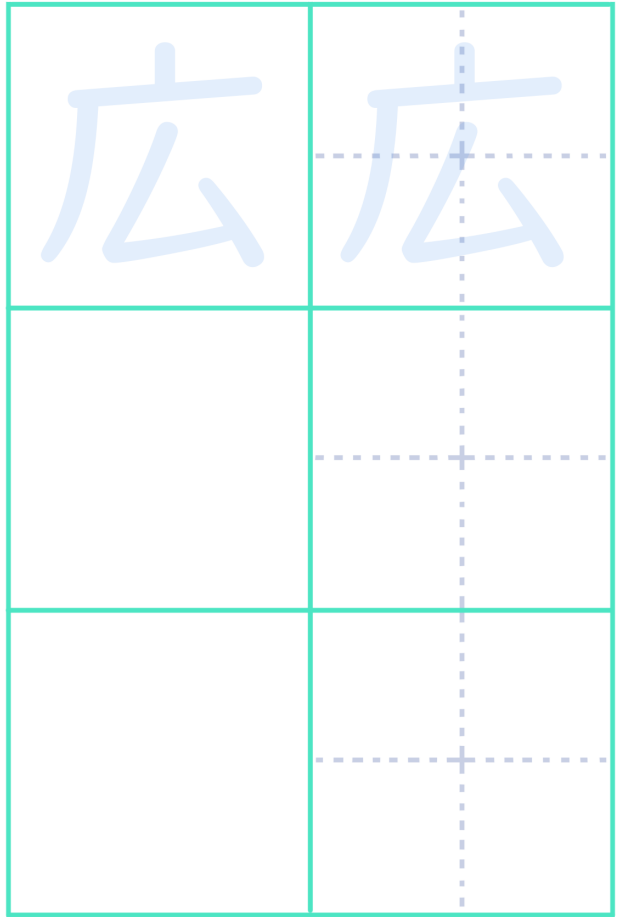

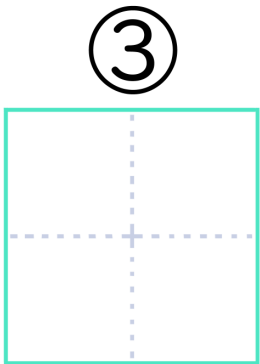
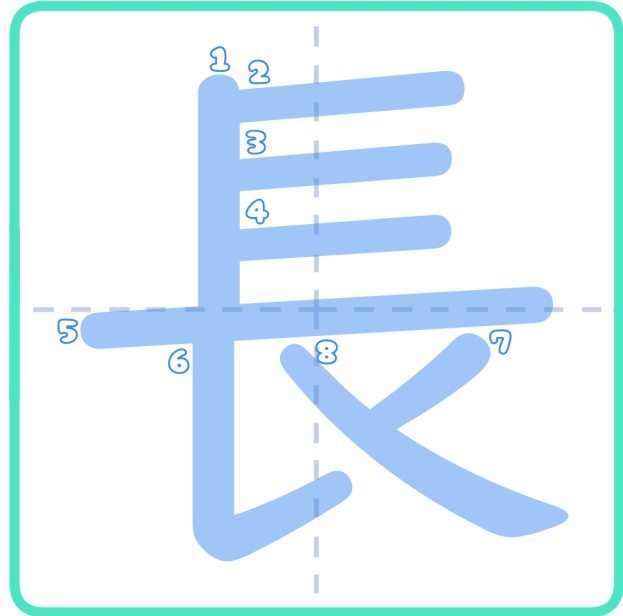
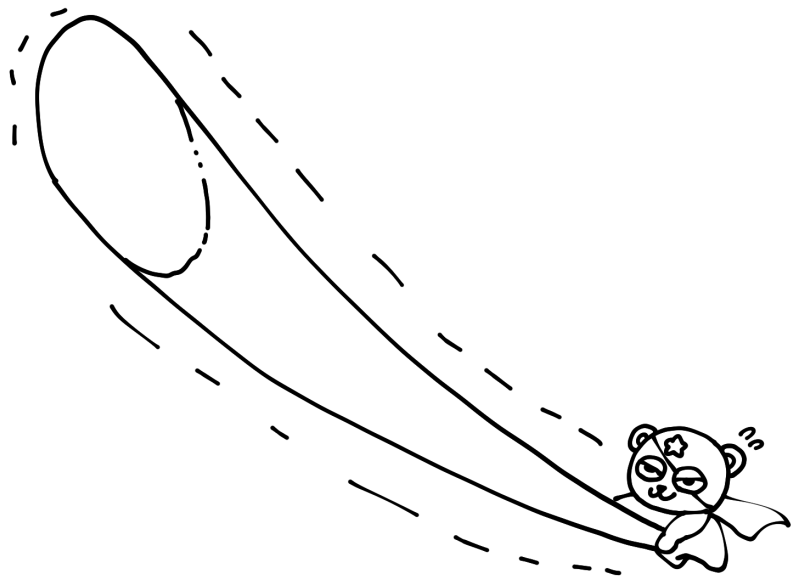

ちよう

③
方ほう
形けい

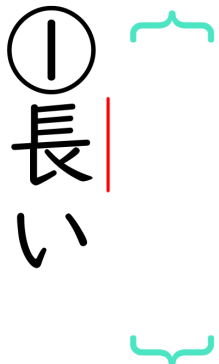

くん
なが
い

おん
ち
よう

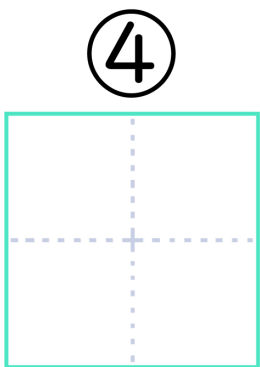

なが

④
い
廊ろう
下か

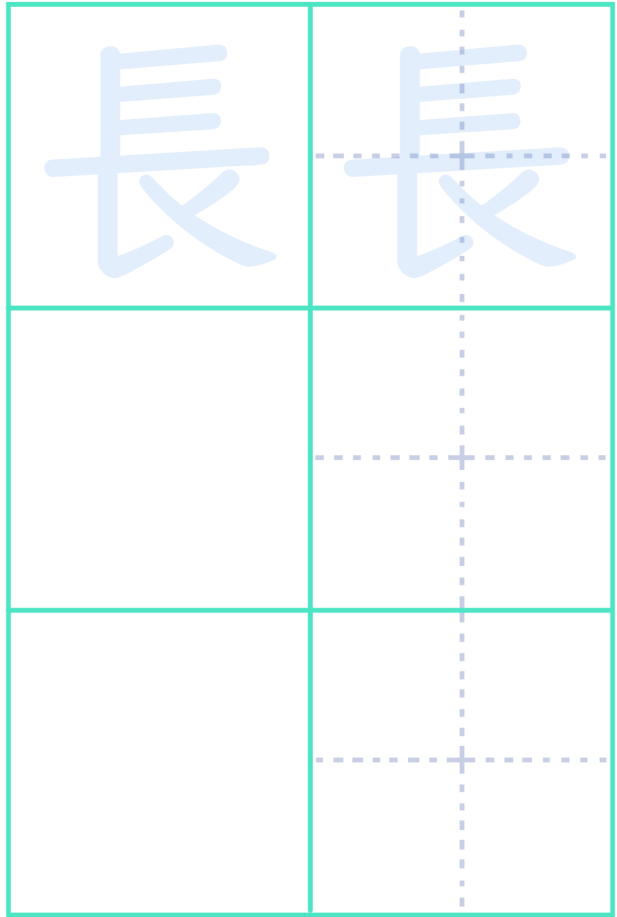

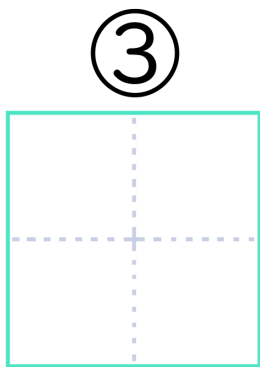
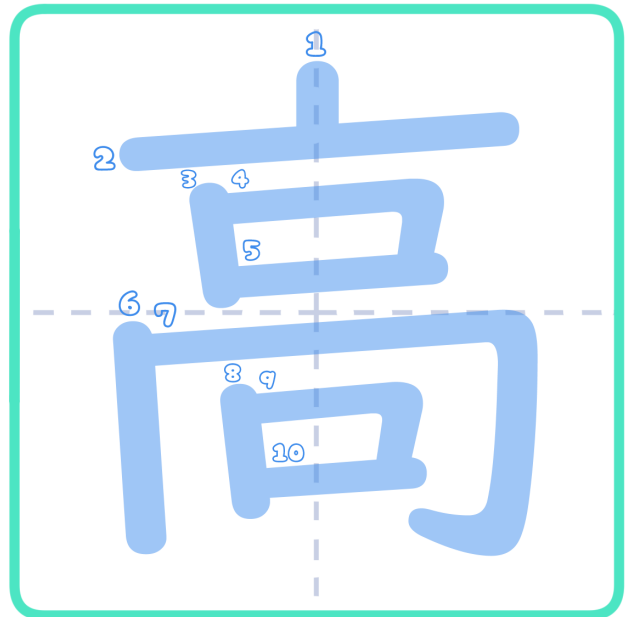

音 おん

こう

① 高い山 やま

くん
たかい

おん
こう

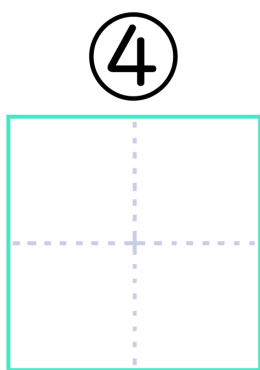

台 だい

たか

② 高原 げん

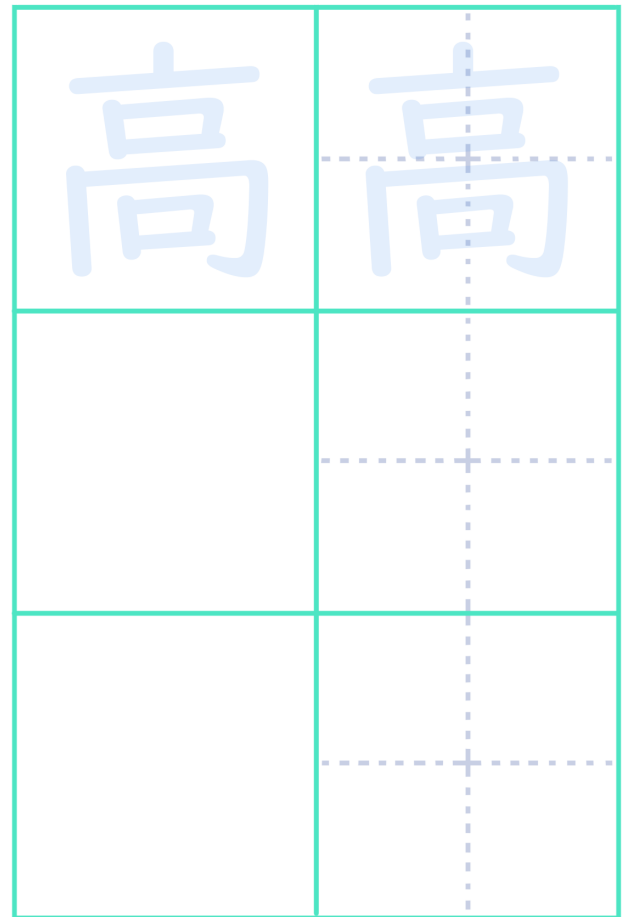

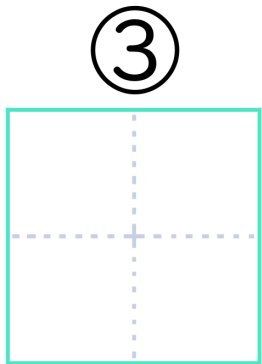
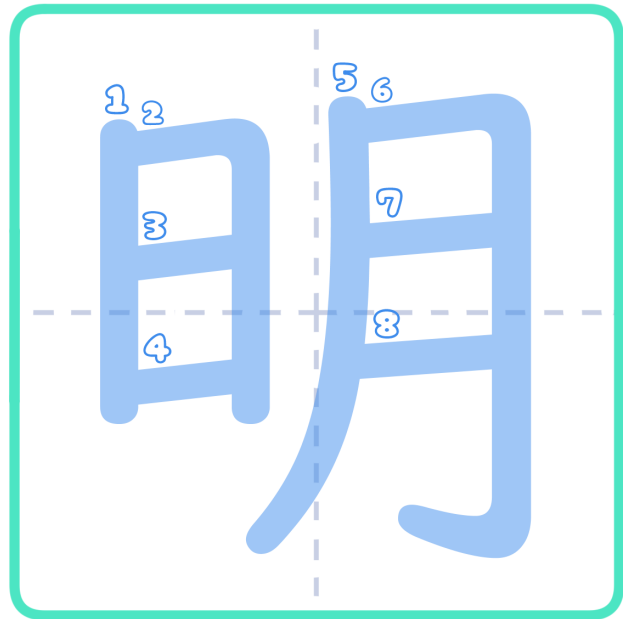

③

あか

る
い

① 発^{はつ}明

くん

おん

あ あ あ あ
け き か か
る ら る り
か い

み め
よ い
う

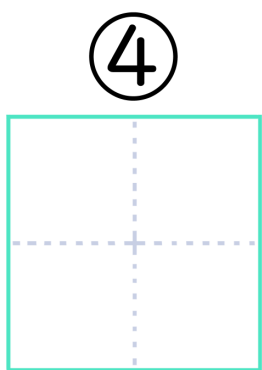

④

みよう

朝^{ちよう}

② 夜^よ明^{めい}け

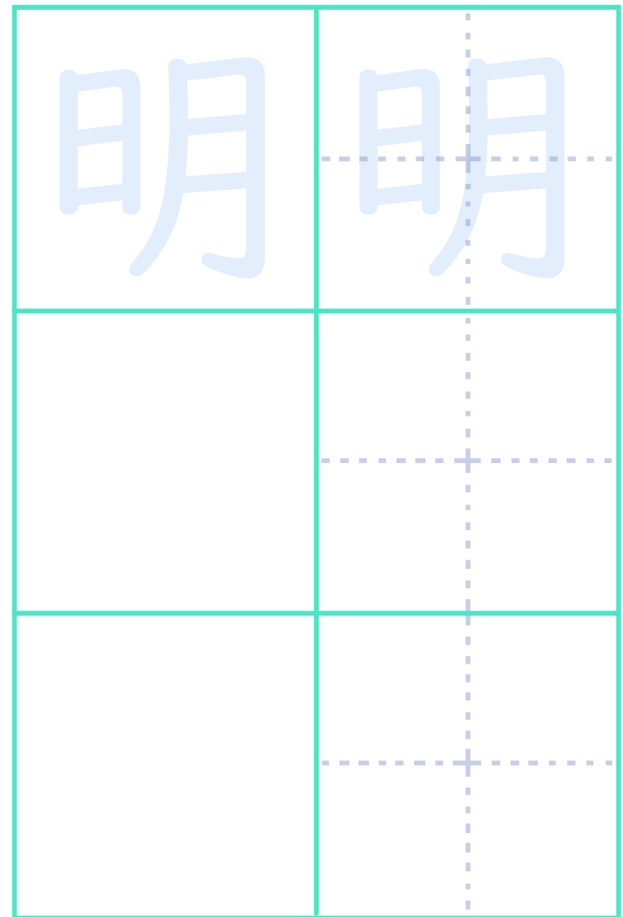

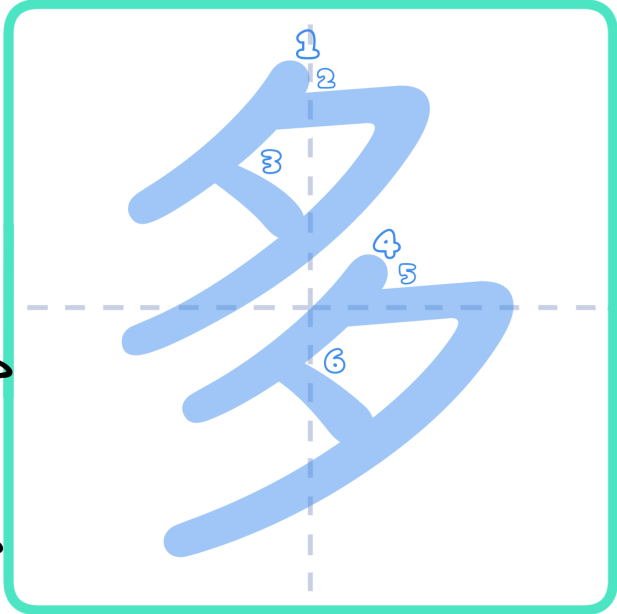
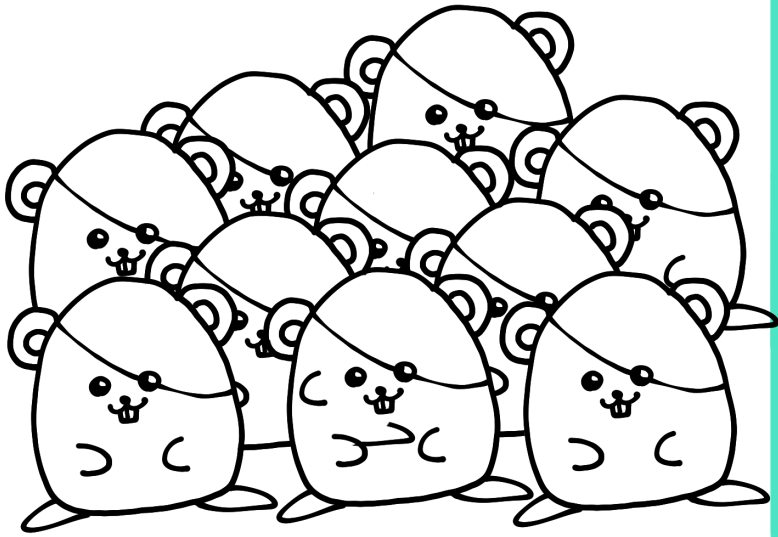

③

た

少 しょう

①

多 た

い

くん

お

お

い

おん

た

④

た

発 はつ

②

多 た

数 すう

多	多



かんじプリント

なまえ

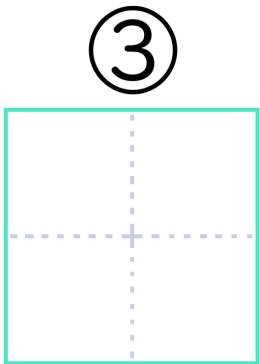
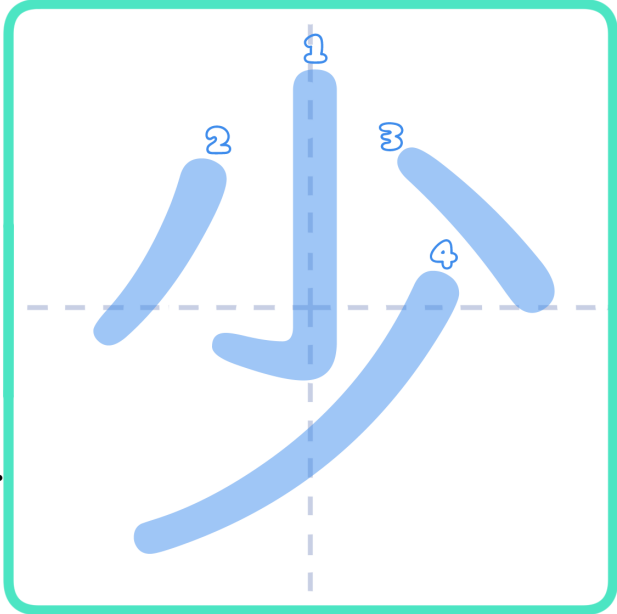
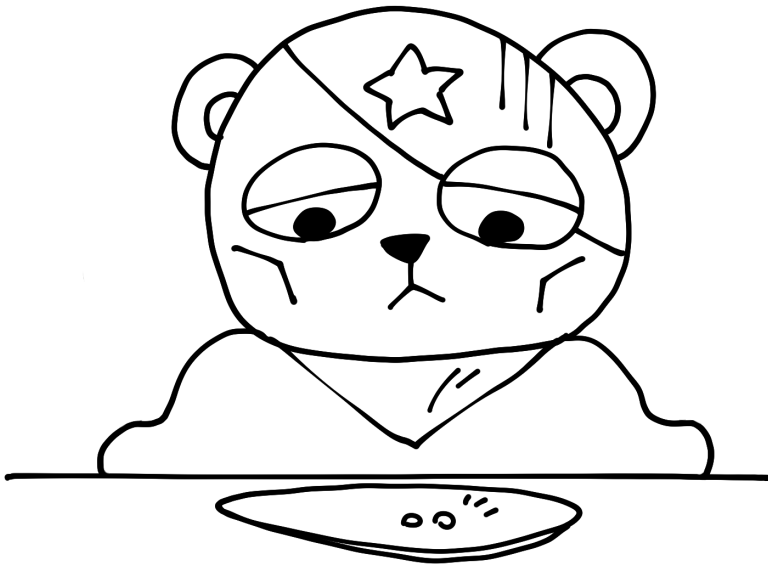

しょう

年 ねん

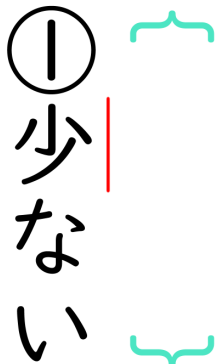

くん
す す
こ く
し ない

おん
し
ょう

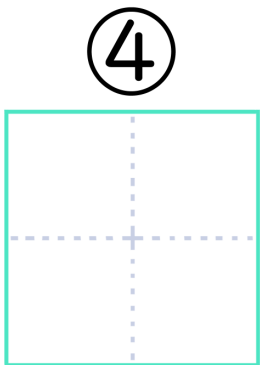

しょう

女 じょ

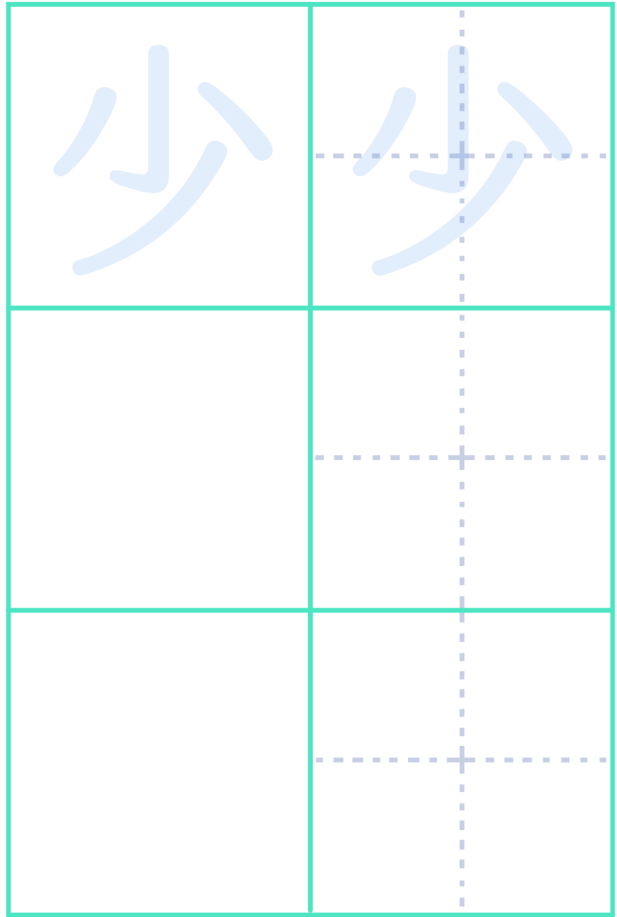
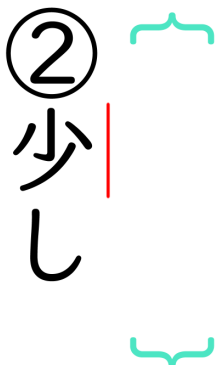

かんじプリント

なまえ

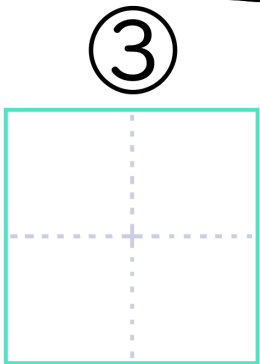
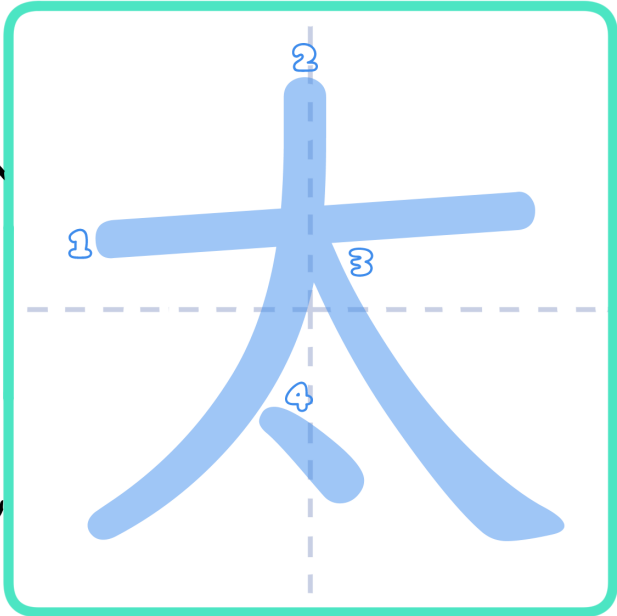
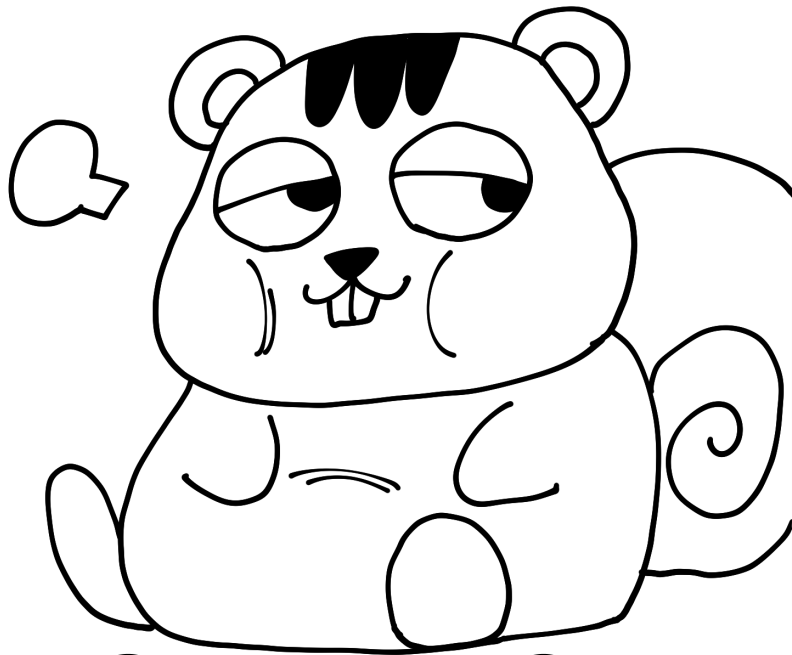

る

ふと

① 太陽 よう

くん

ふふ
とと
るい

おん

たた
たい

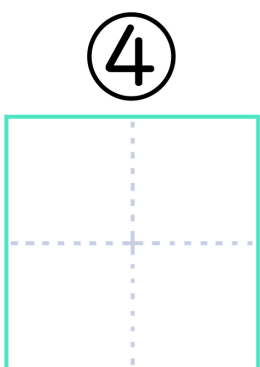

平洋 へいよう

たい

② 丸太 まる

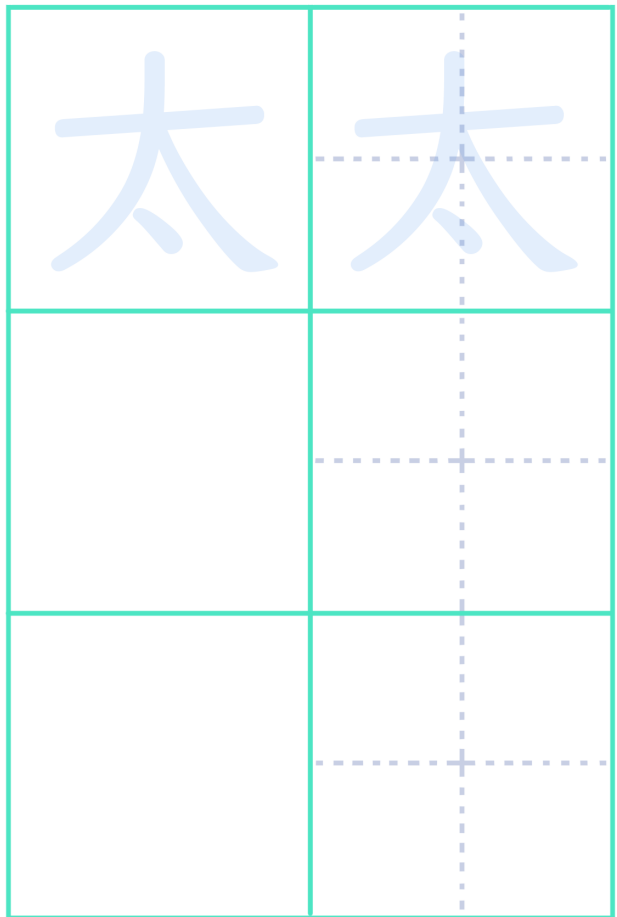

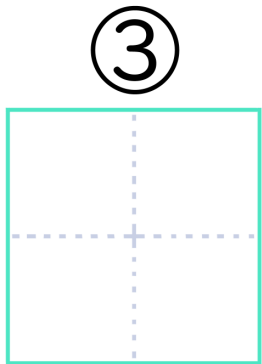
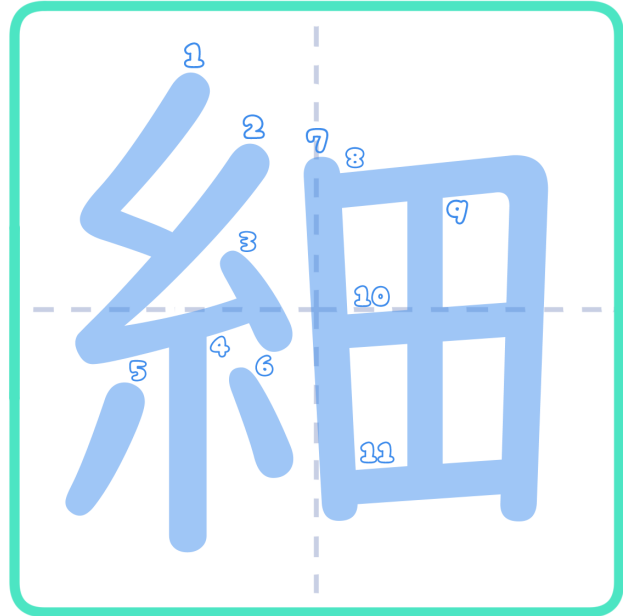

心 しん

① 細 こほ
かい かい

くん
こほ
まそ
かい
い

おん
さい

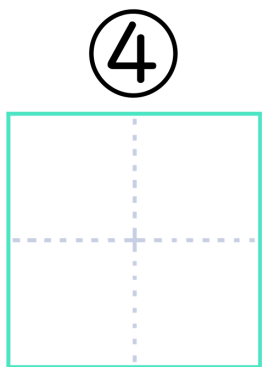

道 みち

② 細 こほ
工 く

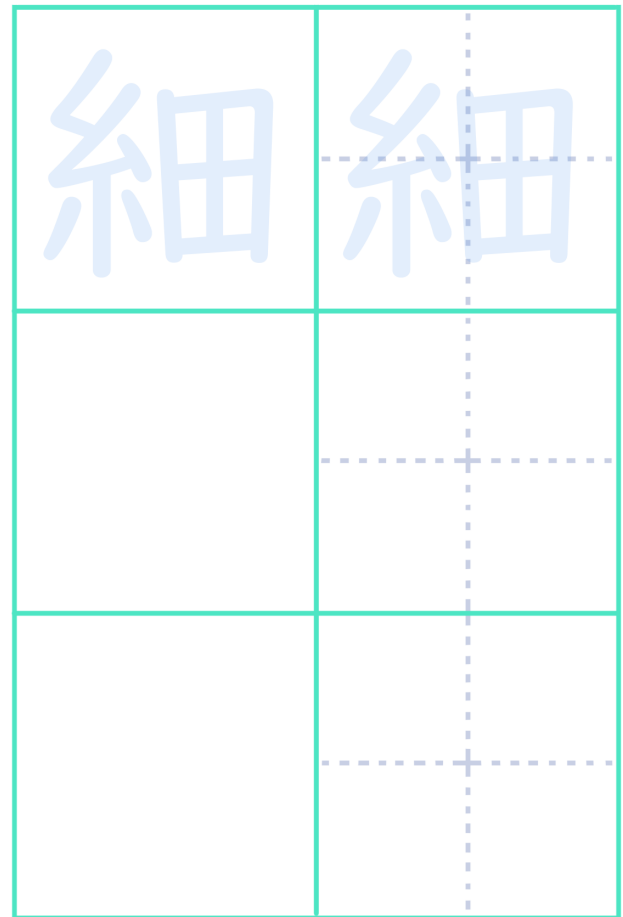

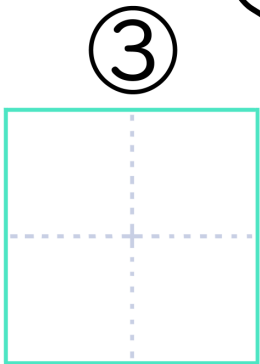
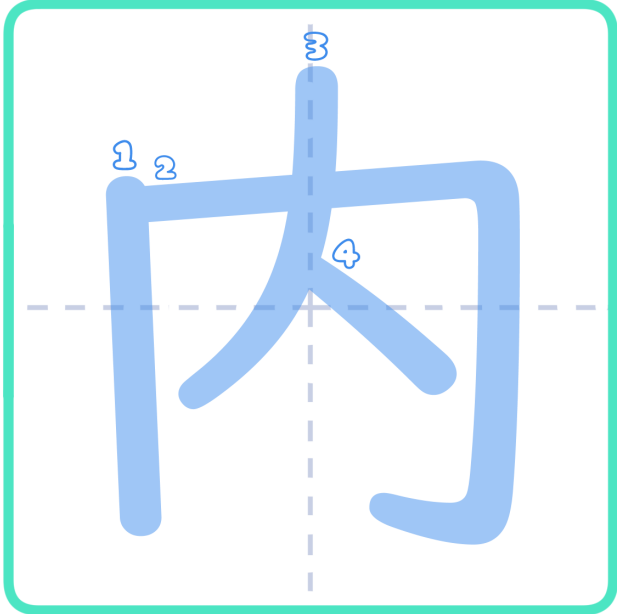

うち

③
気き

① 内側がわ

くん
うち

おん
(ない)

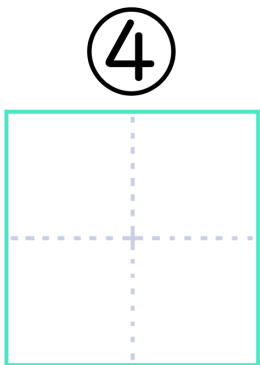

ない

④
緒しよ

② 校内こう

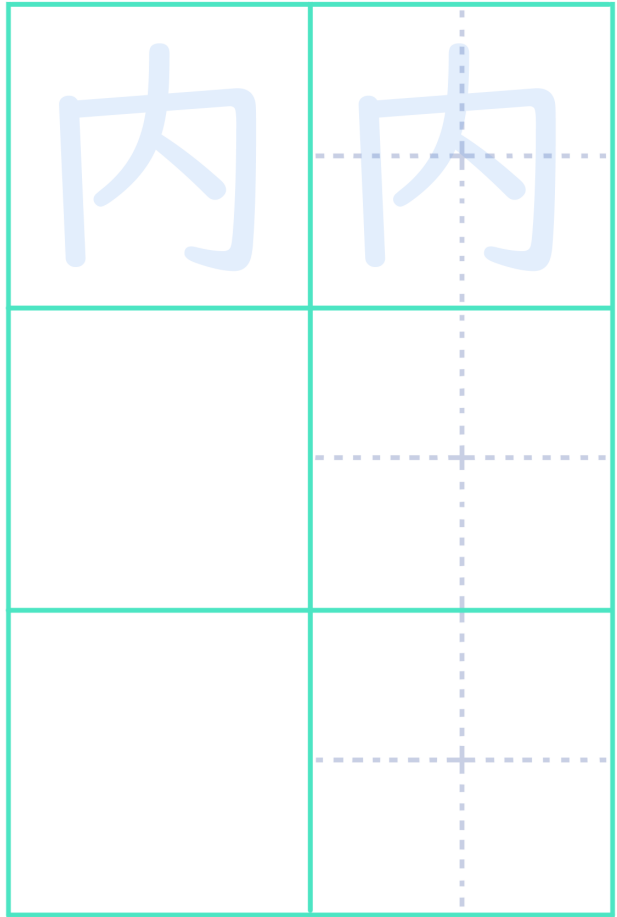

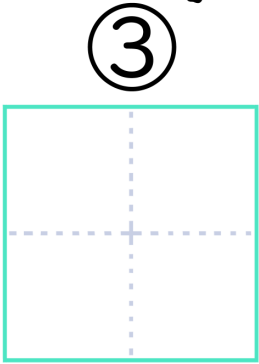
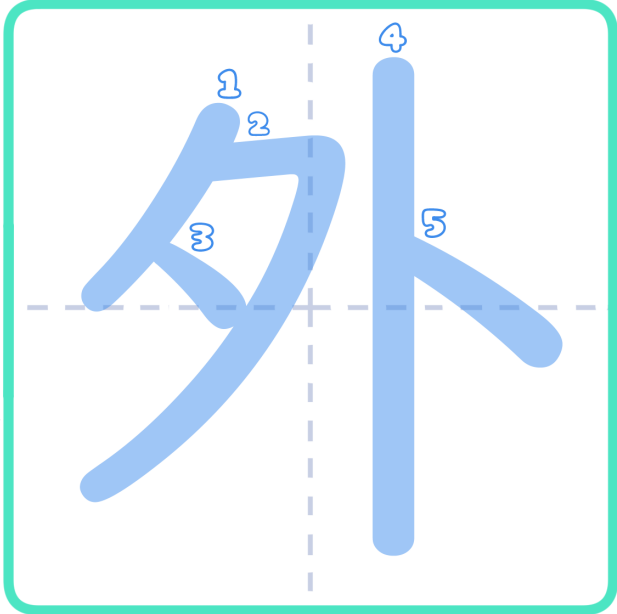

す

はず

① 外側 がわ

くん

おん

ははほそ
ずずかと
れす
る

(げ)が
)い

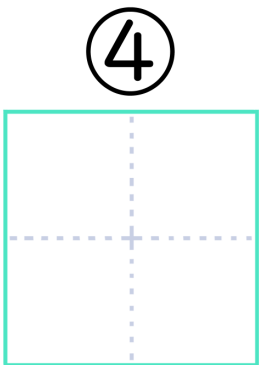

出 で

がい

② 外国 こく

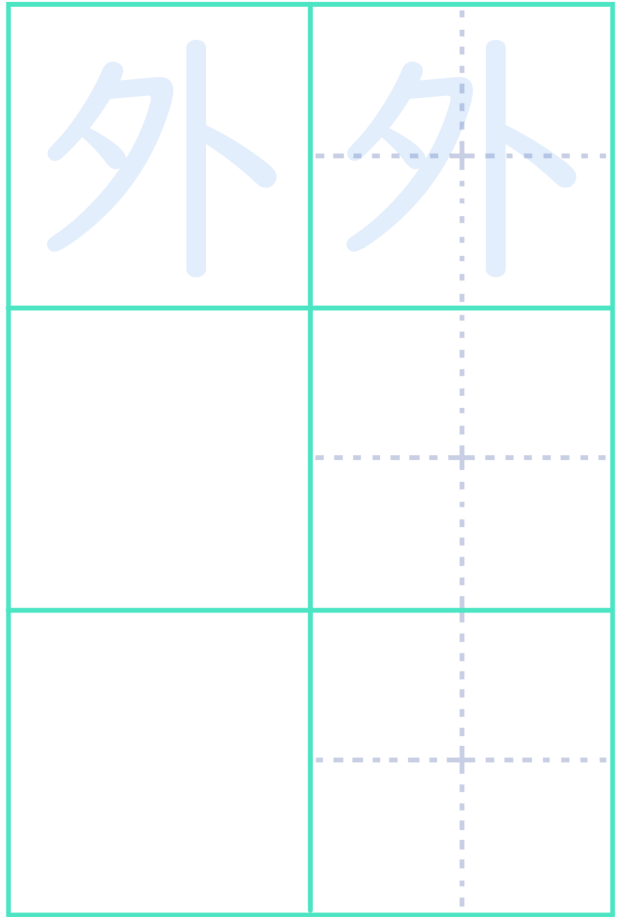

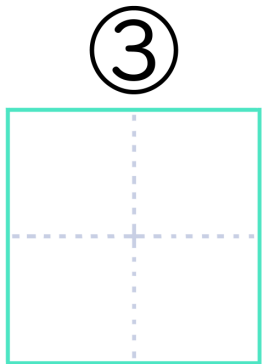
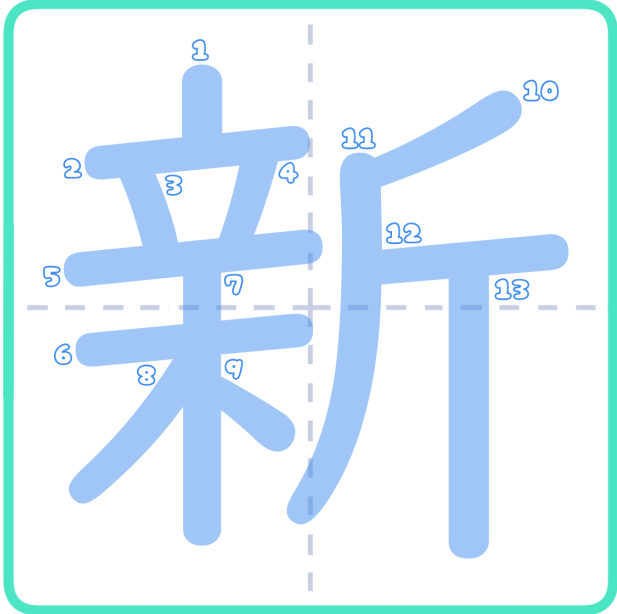

あら

た

① 新聞紙
ぶん し

くん

(にい)
あらた
あたらしい

おん

しん

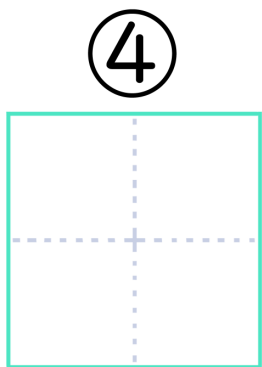

しん

年
ねん

② 新しい
し い

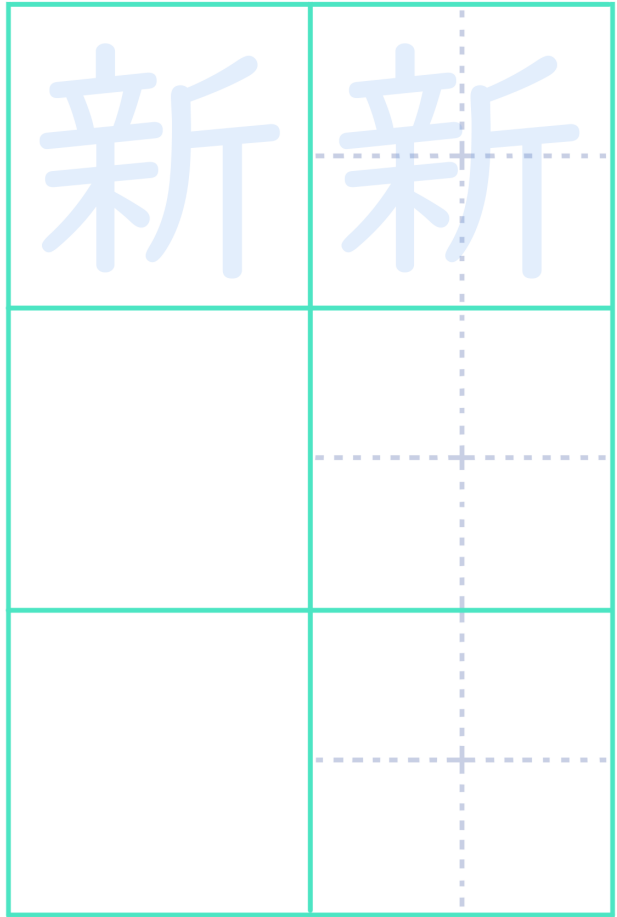

ポイント

新 潟
にいがた

こんな
読み方も
あるよ



かんじプリント

なまえ

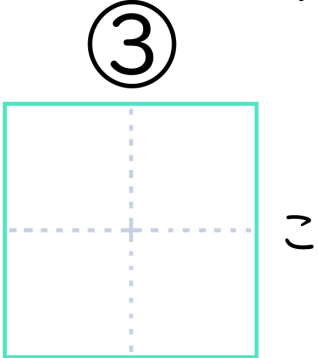
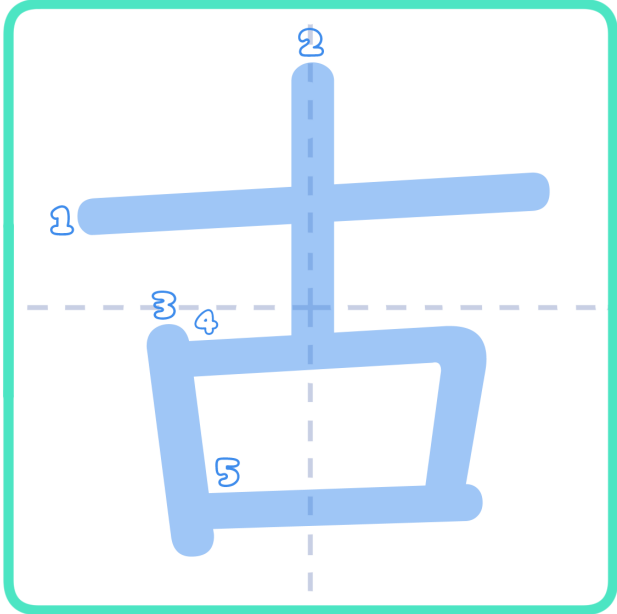

代だい

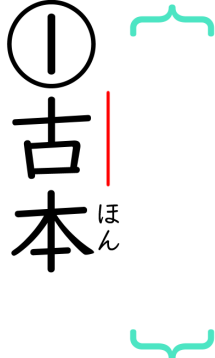

古本ほん

くん
ふる
る
すい

おん
こ

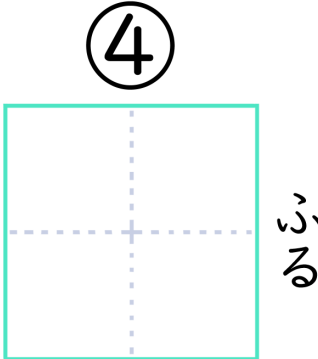

着ぎ

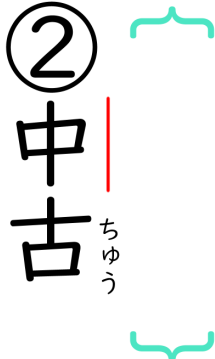

中古ちゅう

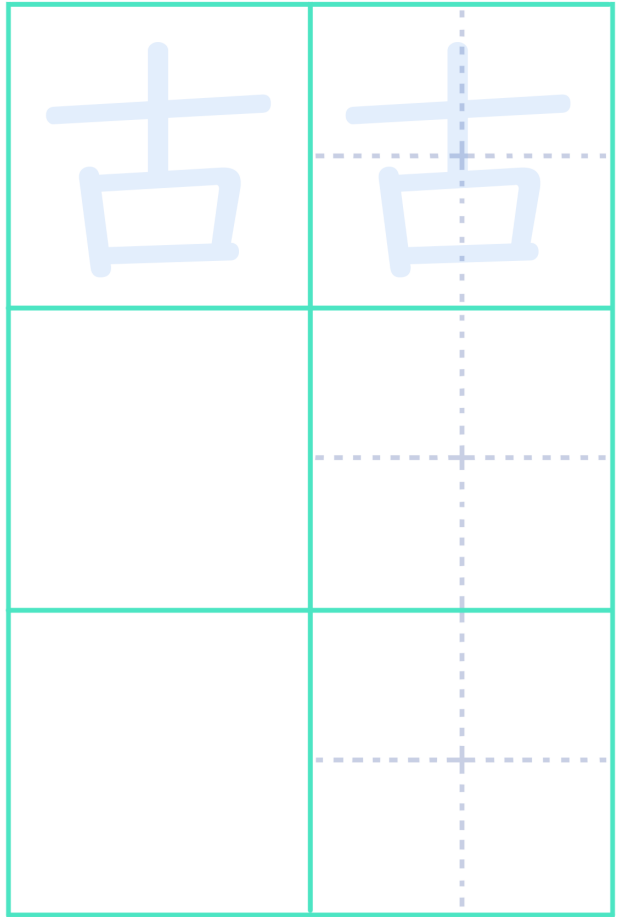

かんじプリント

なまえ

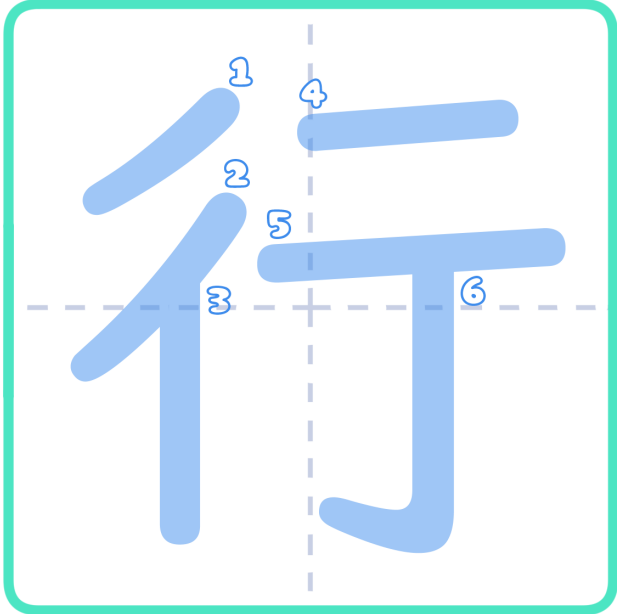
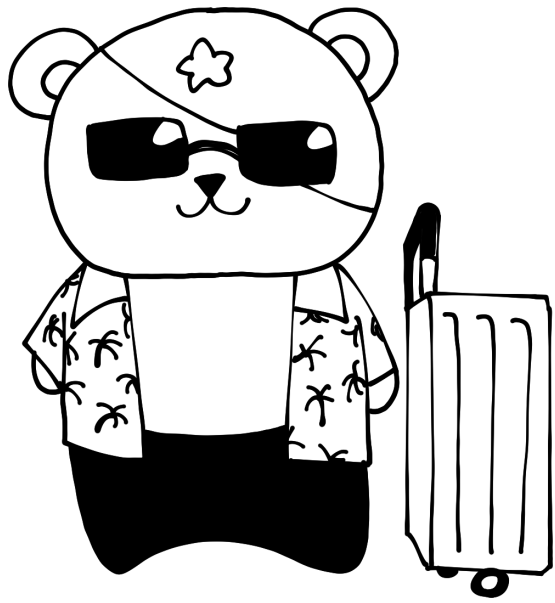

③

い

く

①

旅行りょ

くん

おゆい
おこなう

おん

(あん) ぎょう っこう

④

ぎょう

列れつ

②

行く手て

行	行



かんじプリント

なまえ

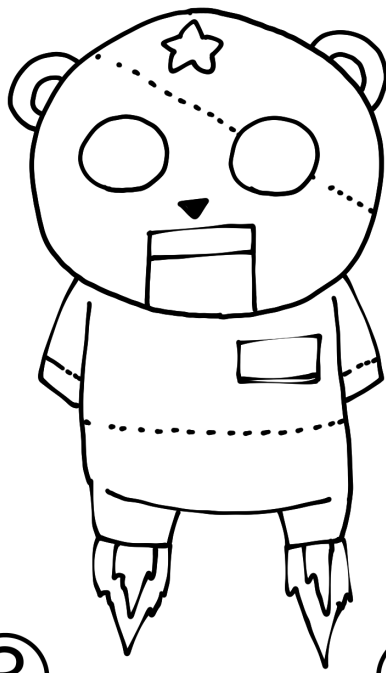

キマシタ
カラ
ミライ

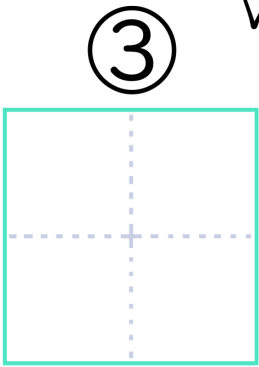
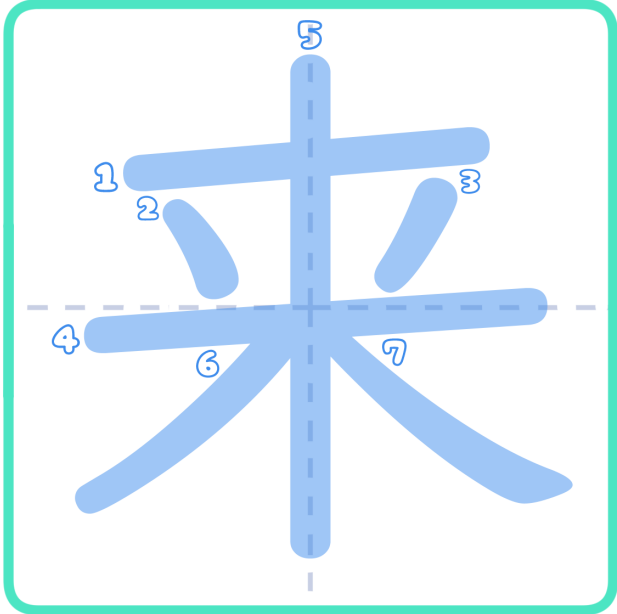

らい

客 きやく

① 来 きる

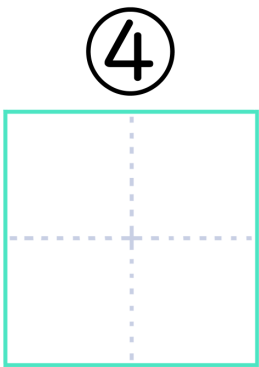

らい

年 ねん

② 未 み来

くん
(き) くる
きたる

おん
らい

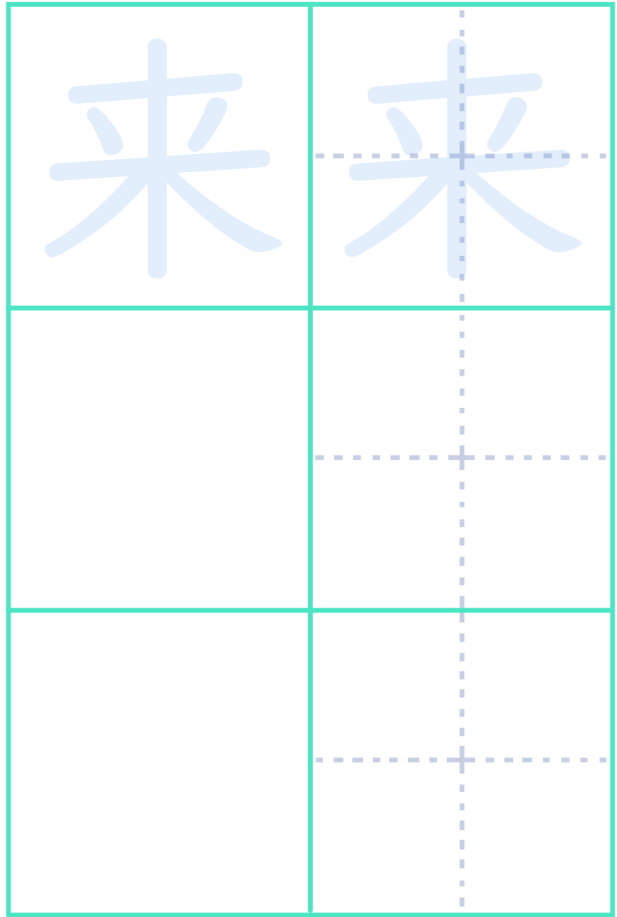

かんじプリント

なまえ

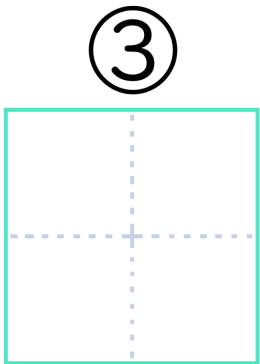
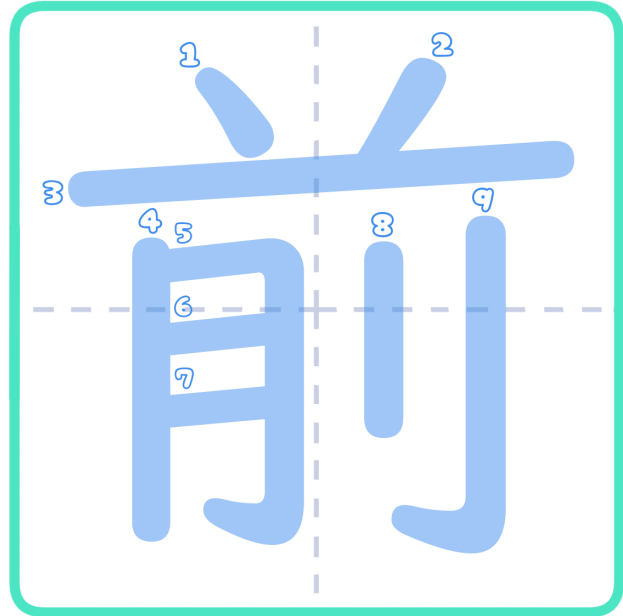

ぜん

半 はん

① 名前 なまえ

くん
まえ

おん
ぜん

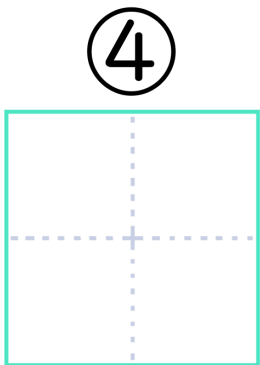

まえ

歯 は

② 前日 まじつ

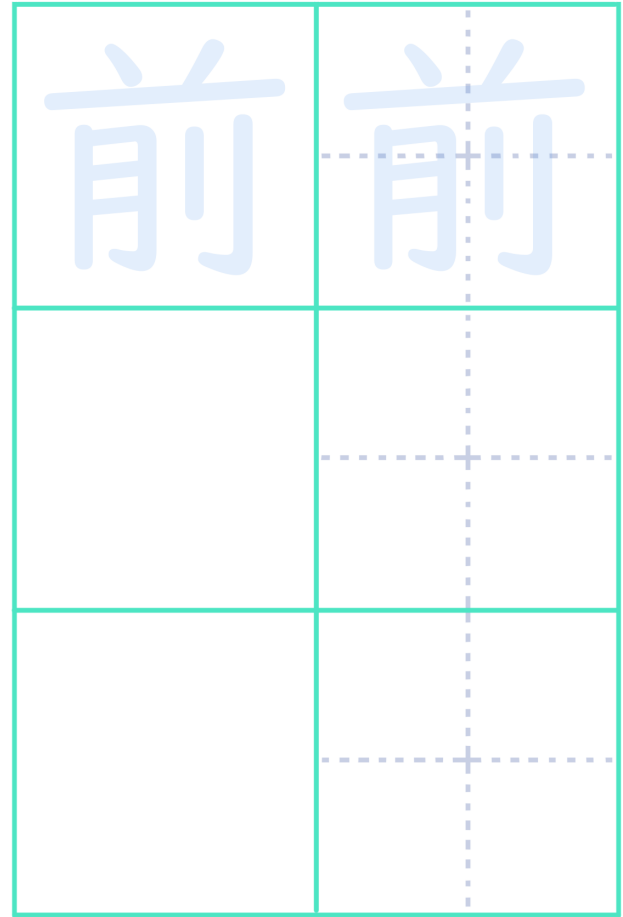

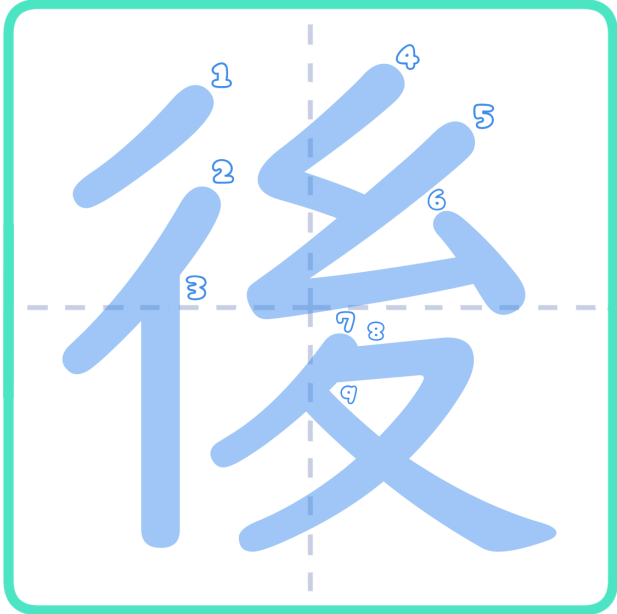
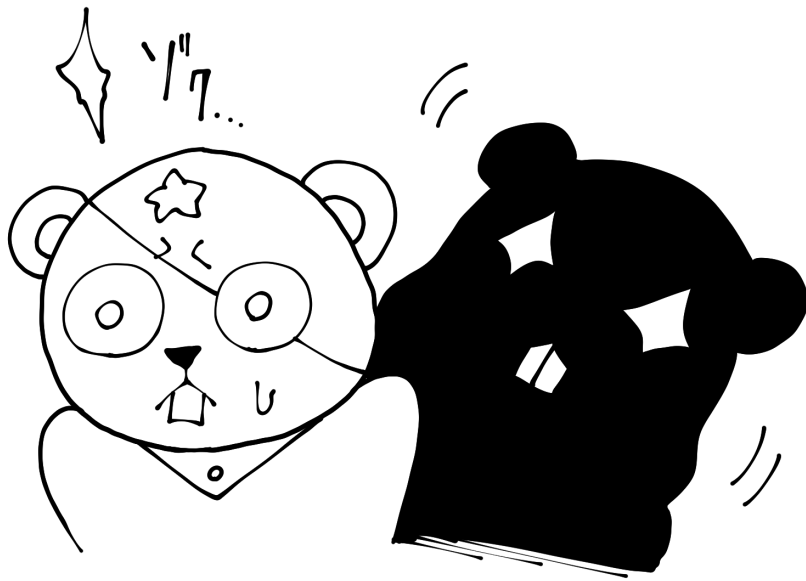

③

うし

ろ

① 後回し まわ

くん

あとのち
（おくれる）
うしろ

おん

こうご

④

こう

方 ほう

② 前後 ぜん

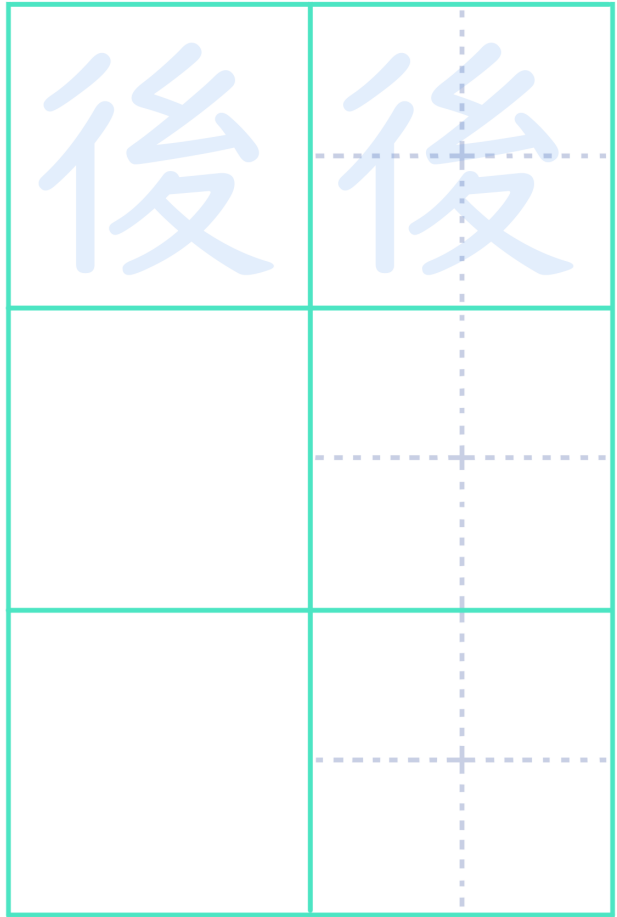

かんじプリント

なまえ

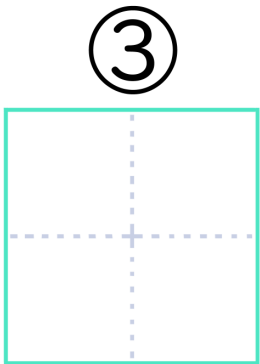
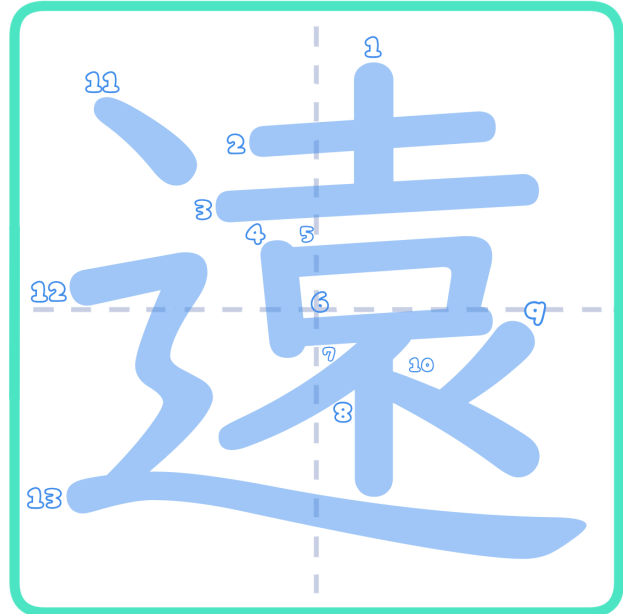

とお

い
国くに

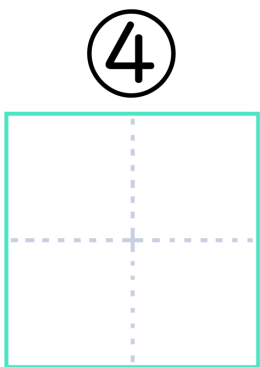

えん

方ほう

① 遠足そく

② 遠回りまわ

くん
と
お
い

おん
(おん えん)

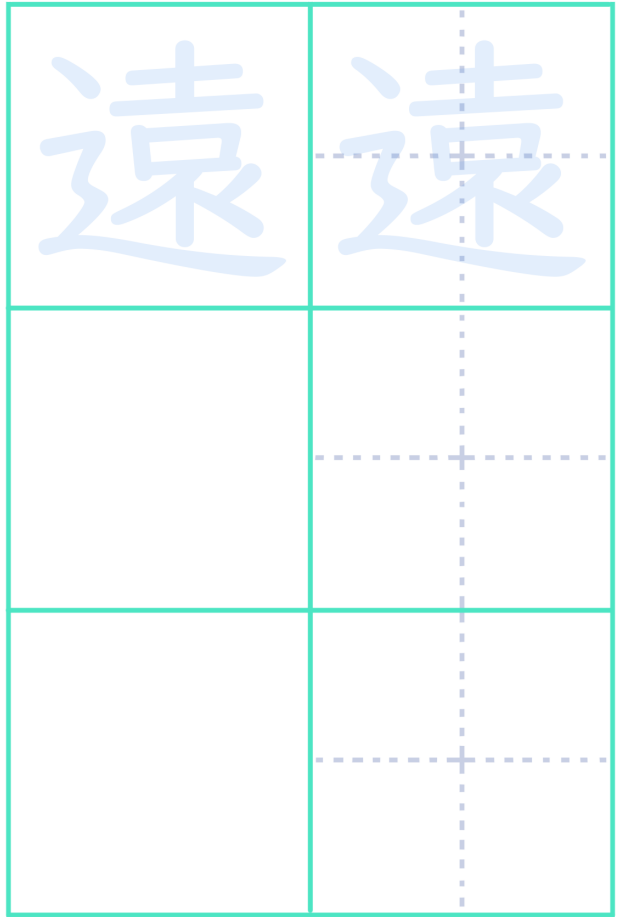

かんじプリント

なまえ

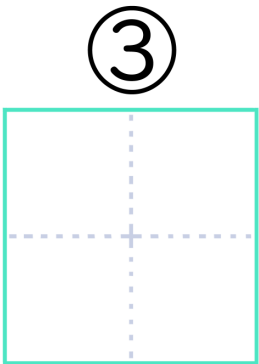
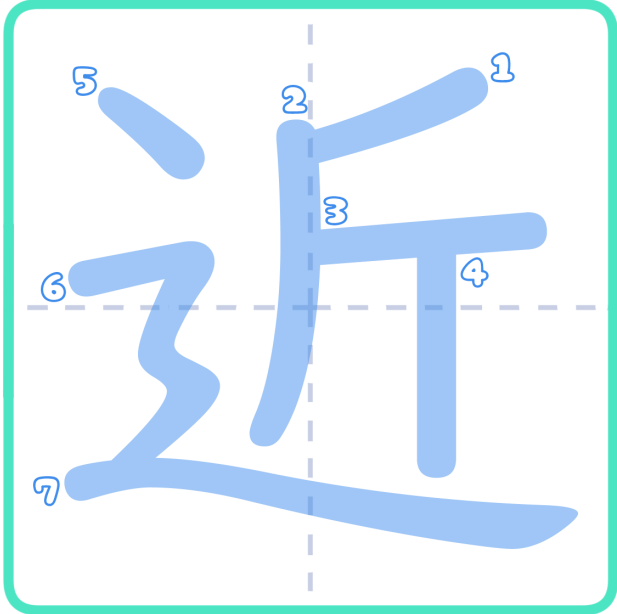
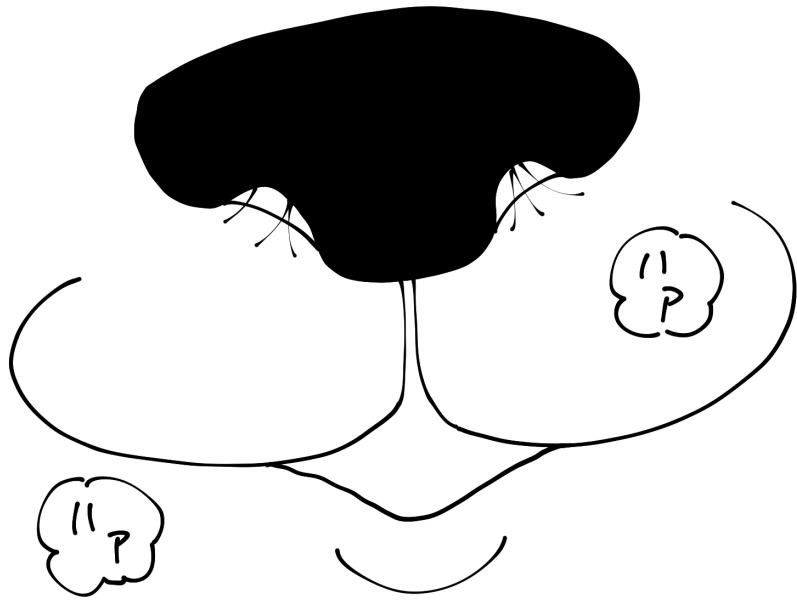

ちか

道 みち

① 近 ちか
づく い

くん
ち
か
い

おん
き
ん

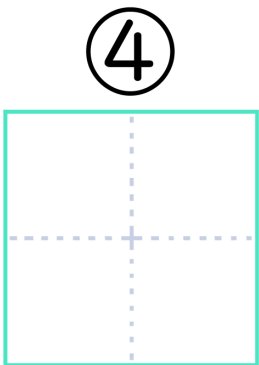

きん

所 じよ

② 最 さい
近 い

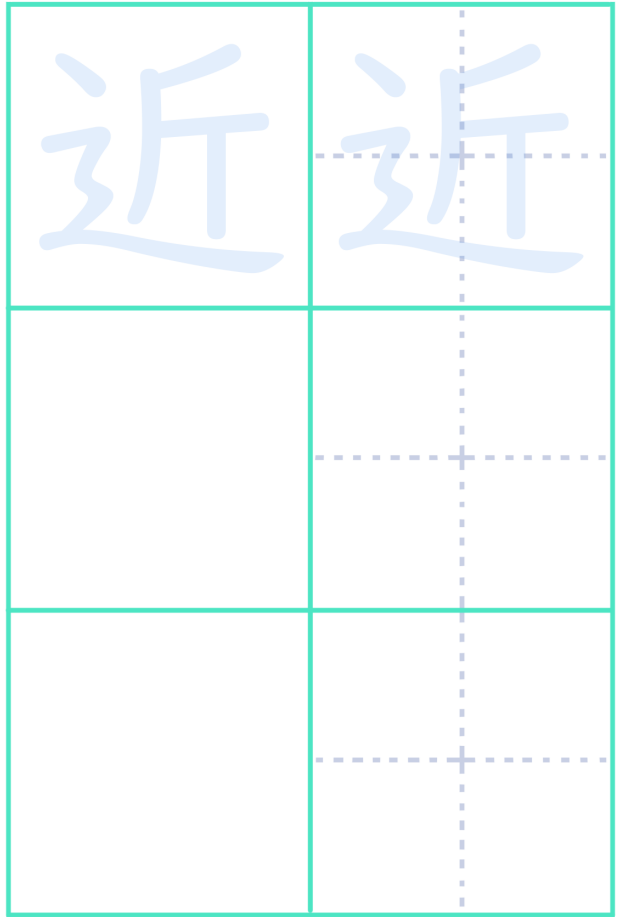

かんじプリント

なまえ

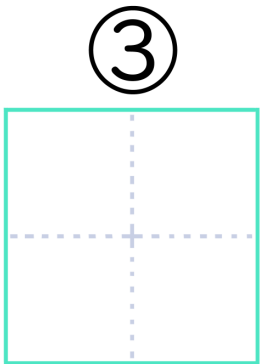
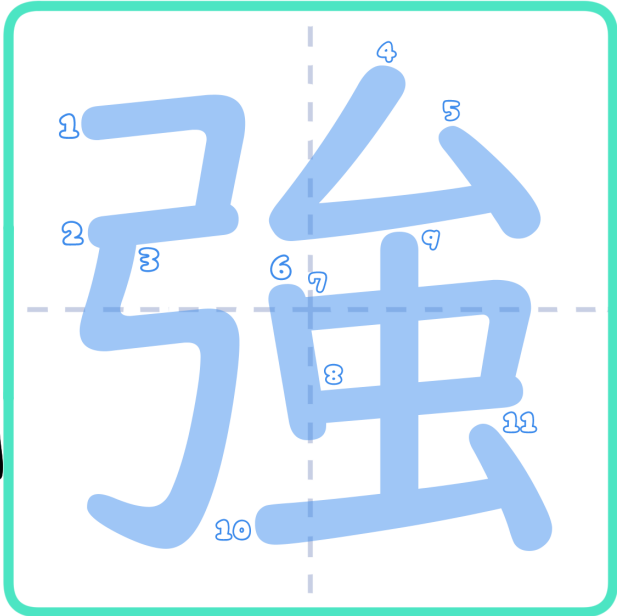
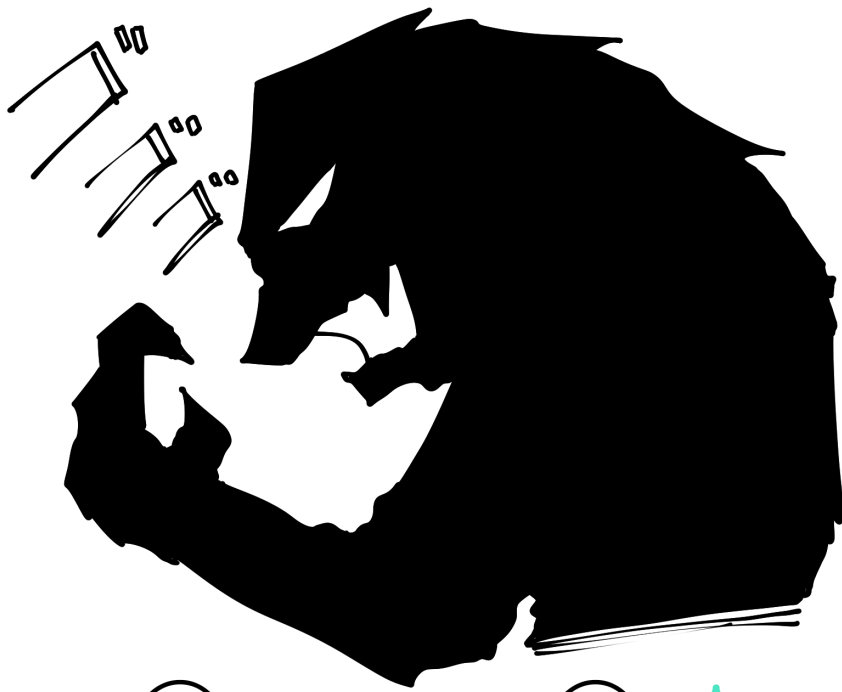

引

引 いん

① 強い力 ちから

くん (しいる) つよい

おん (きょう)

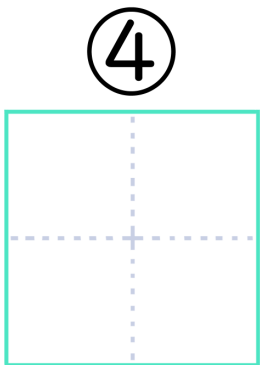

つよ

気 き

② 強敵 てき

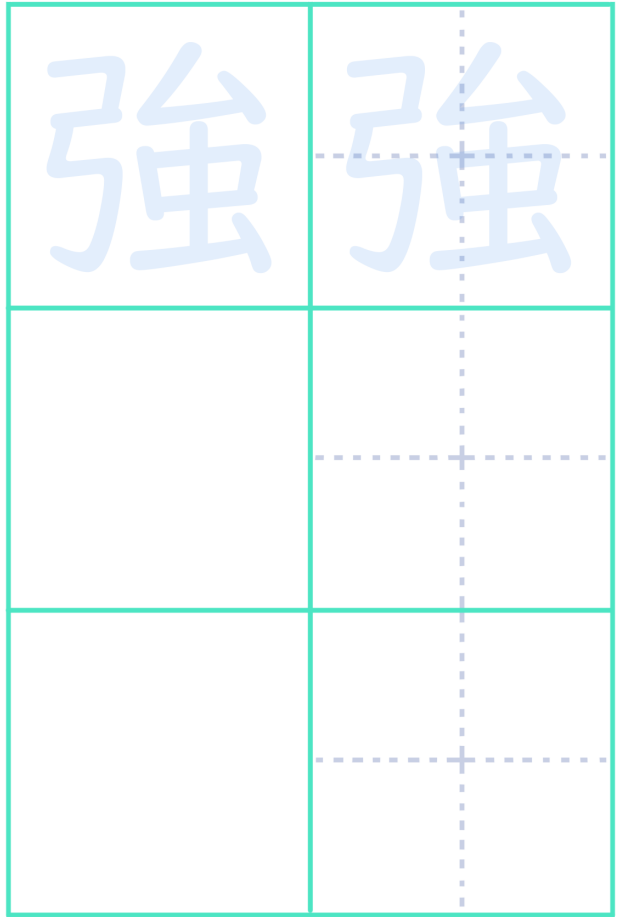

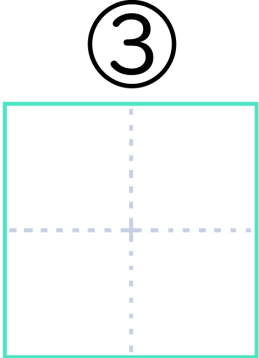
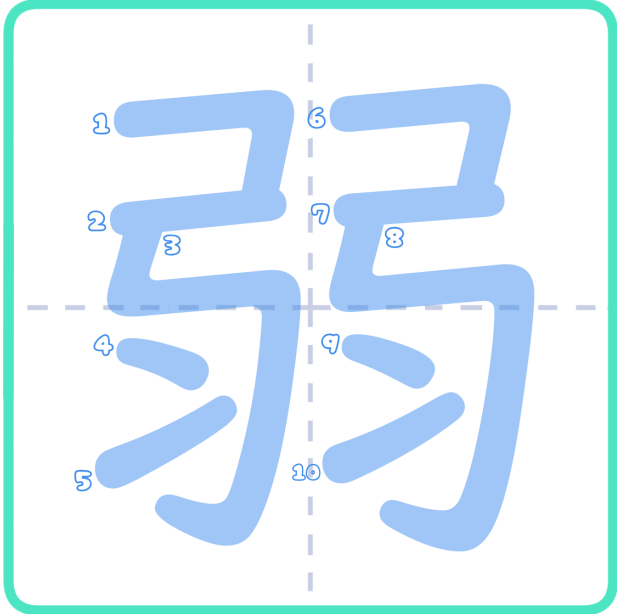

③

よわ

火_び

① 弱_き気

くん
よわ
い

おん
じやく

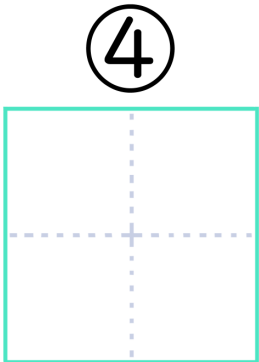

④

じやく

点_{てん}

② 強_{きやう}弱

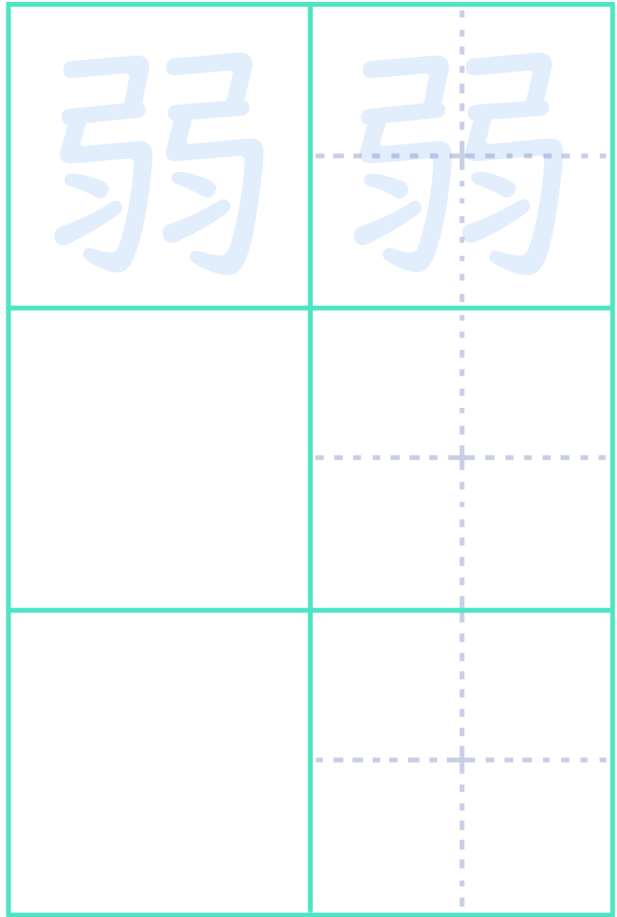

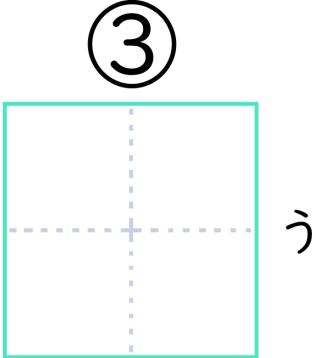
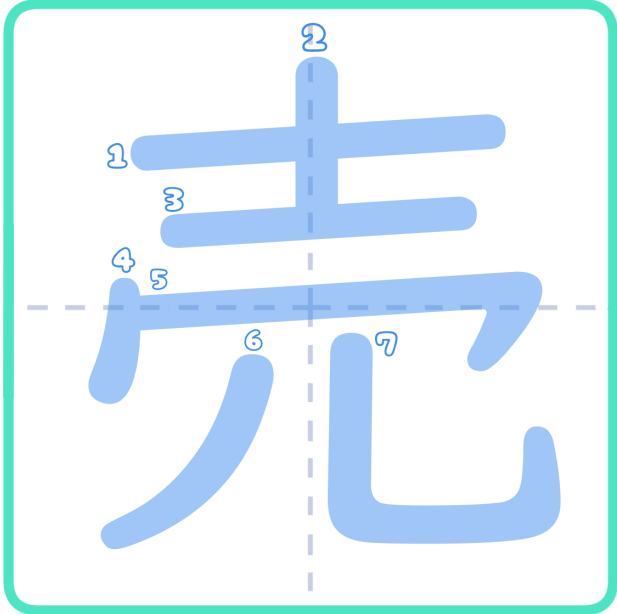

り場ば

① 売りれる

くん
うう
れるる
る

おん
ばい

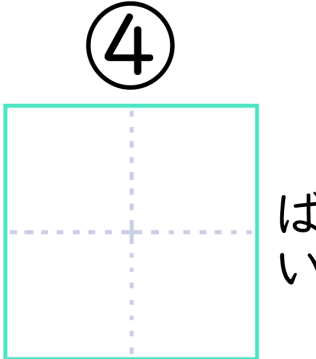

店てん

② 発はつ売

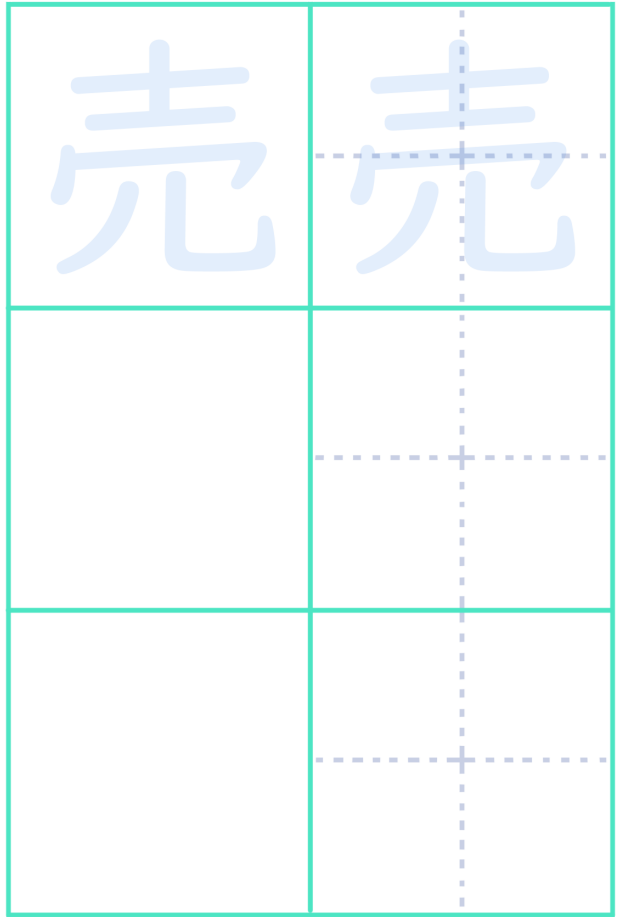

かんじプリント

なまえ

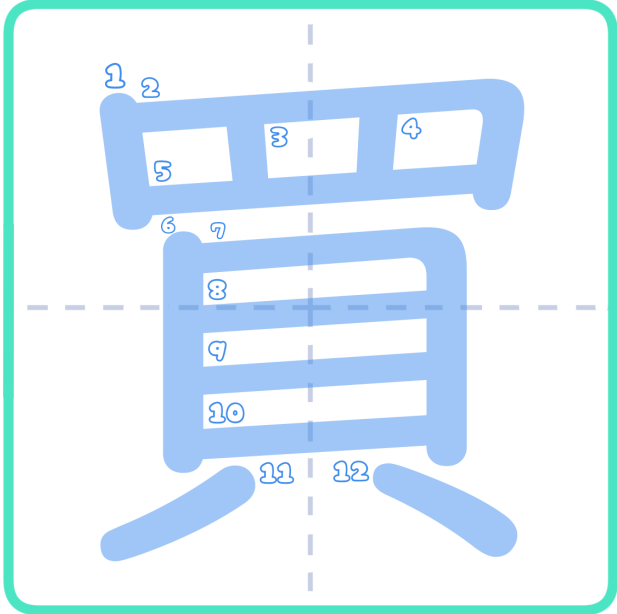
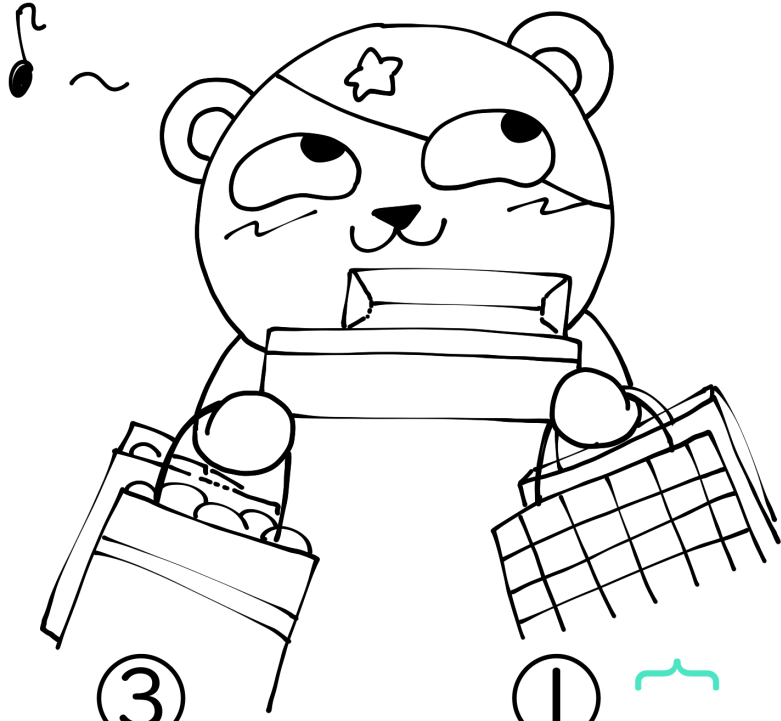

③

か

う

① 買

い

物もの

くん

か

う

おん

ば

い

④

か

い

手て

② 購

買かう

買	買

