

③

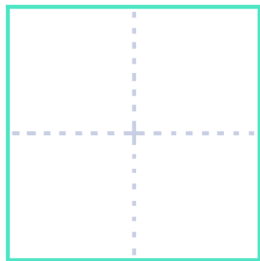

のう

業ぎやう

①

農場じやうじやう

④

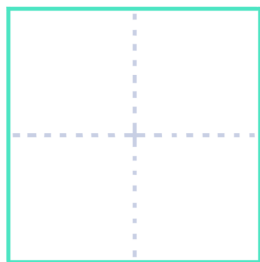

のう

地ち

②

農家のうか

くん

おん

のう

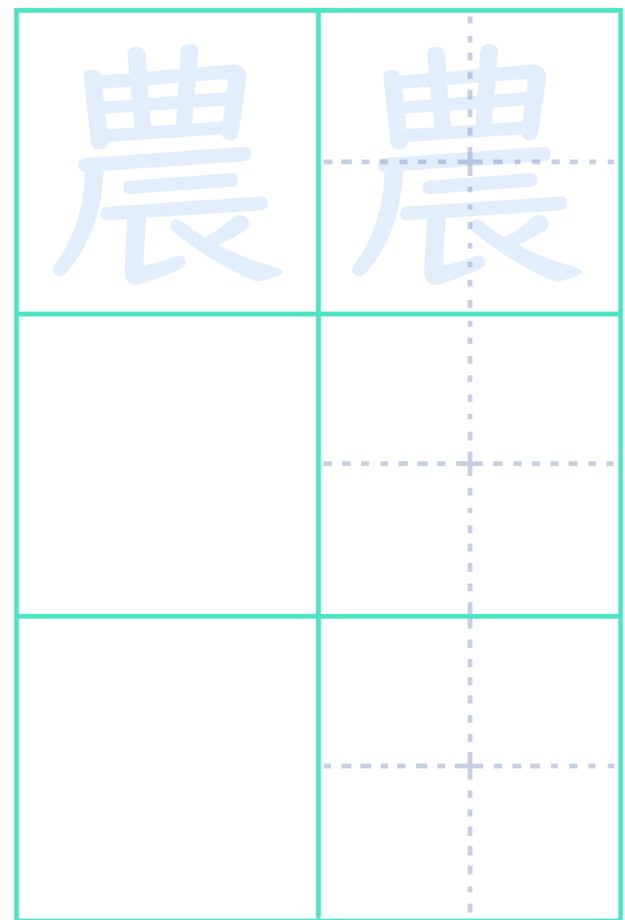

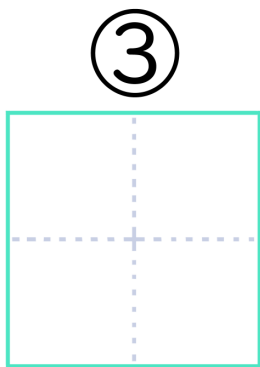
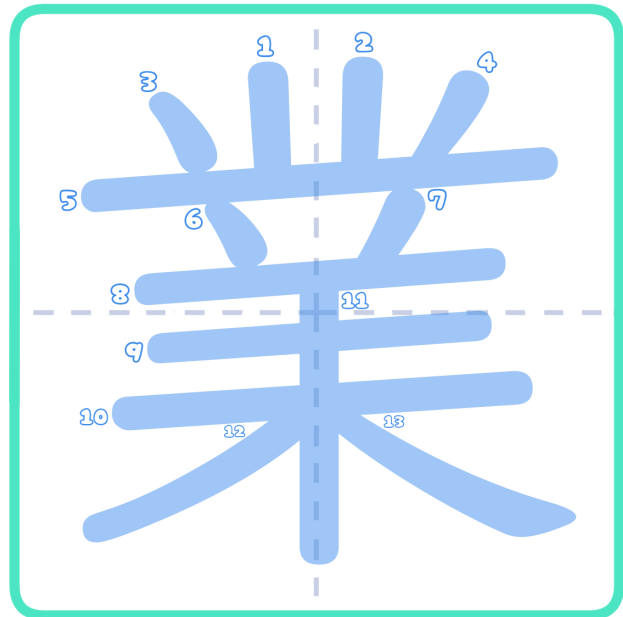

ほう

火 か

① 授業 じゆぎ

くん  
(わざい)

おん  
(ぎよう)

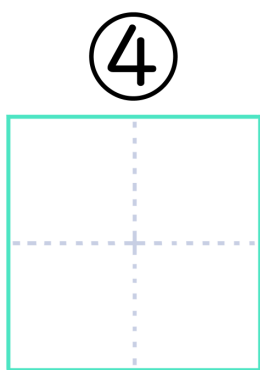

ぎよう

務 む

② 作業 さぎ

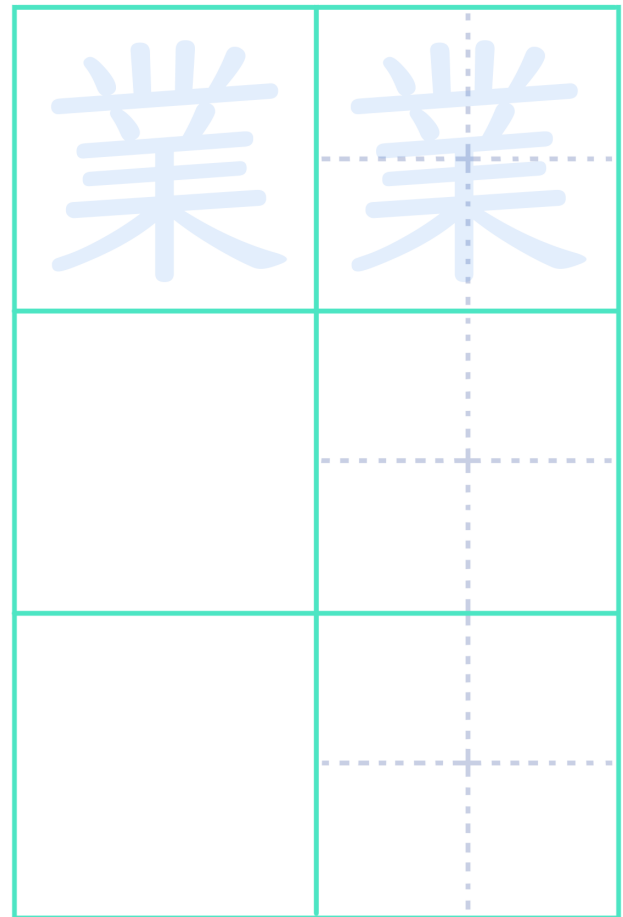

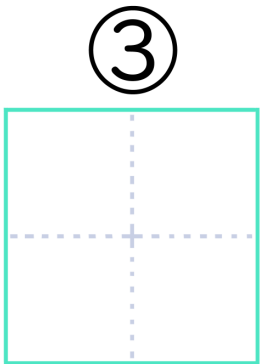
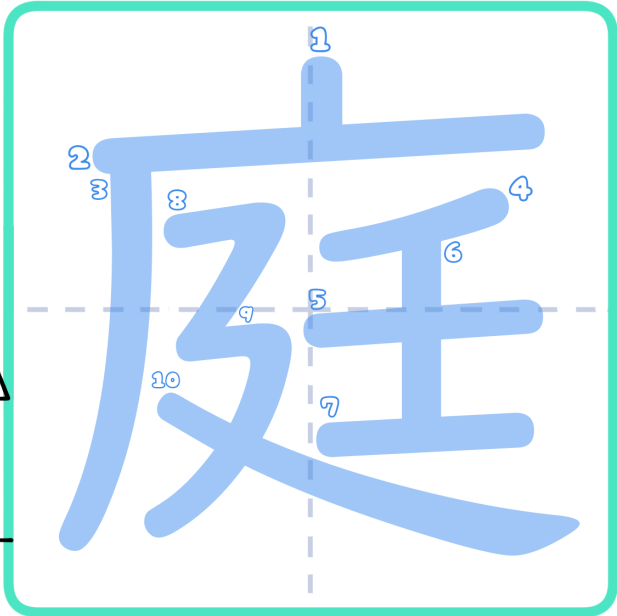
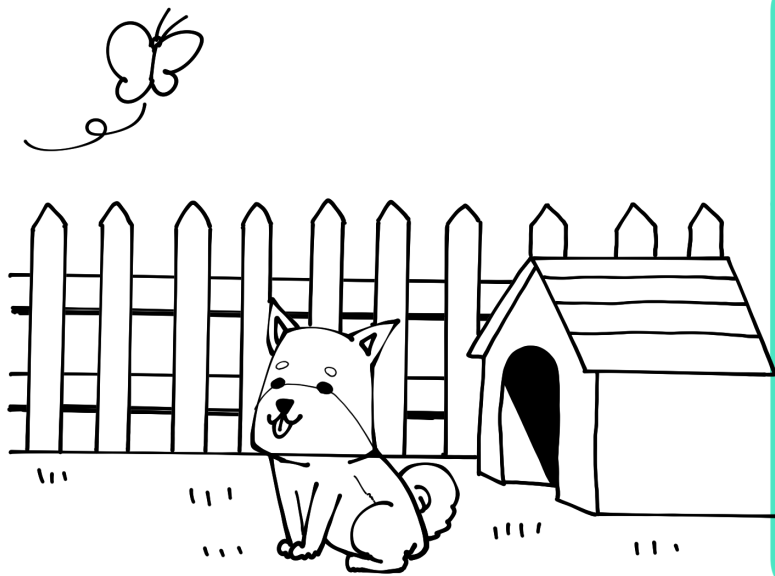

③

にわ

師し

①  
校こう  
庭

くん  
にわ

おん  
てい

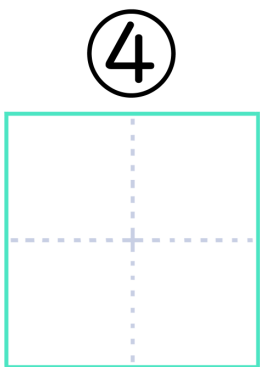

④

てい

園えん

②  
中なか  
庭

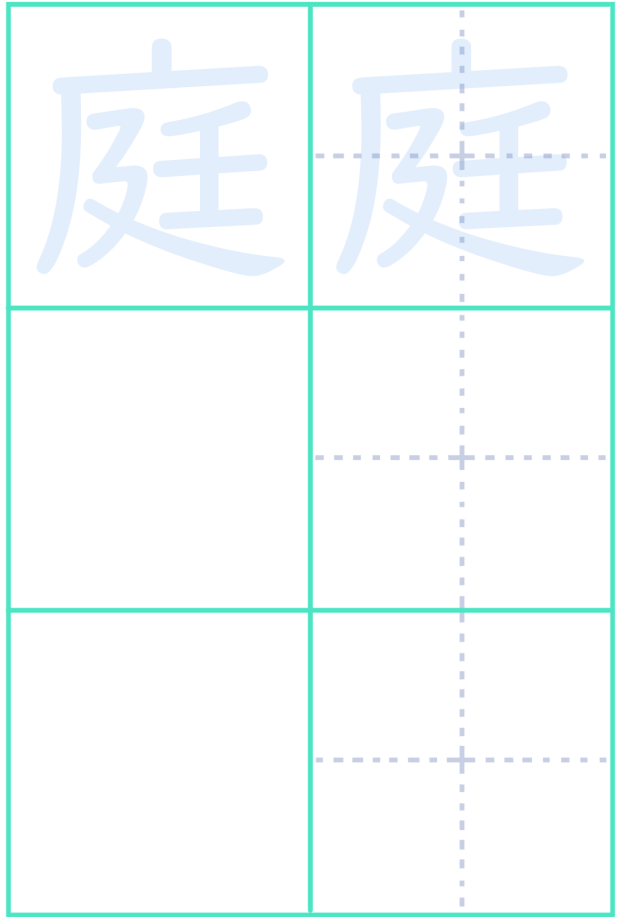

かんじプリント

なまえ

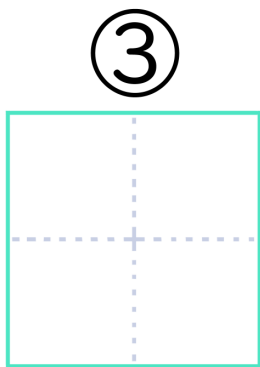
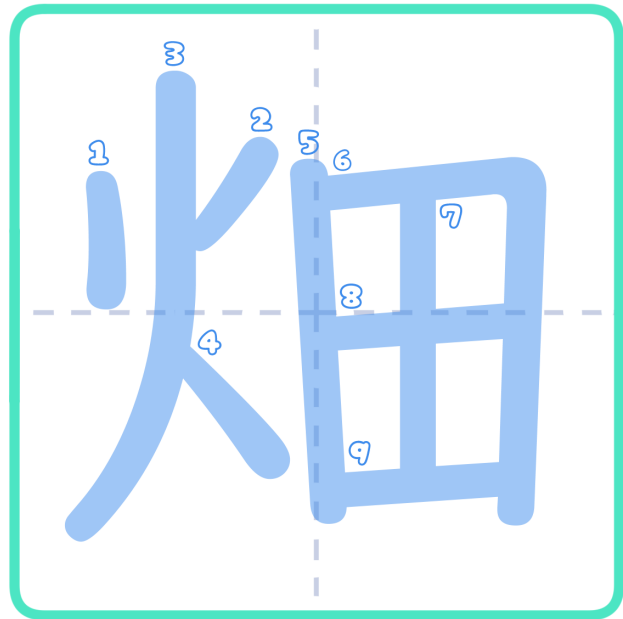
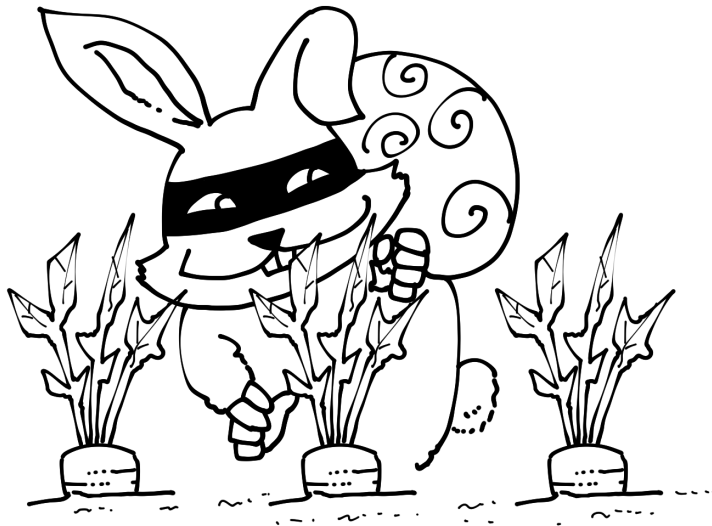

はた

作さく

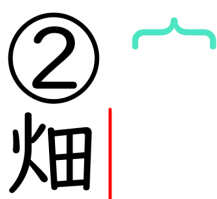
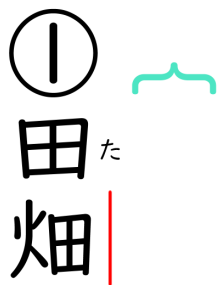

くん

おん

はは  
たた  
け

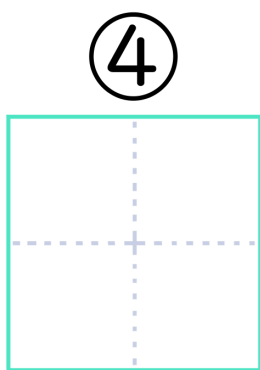

はたけ

仕し  
事じ

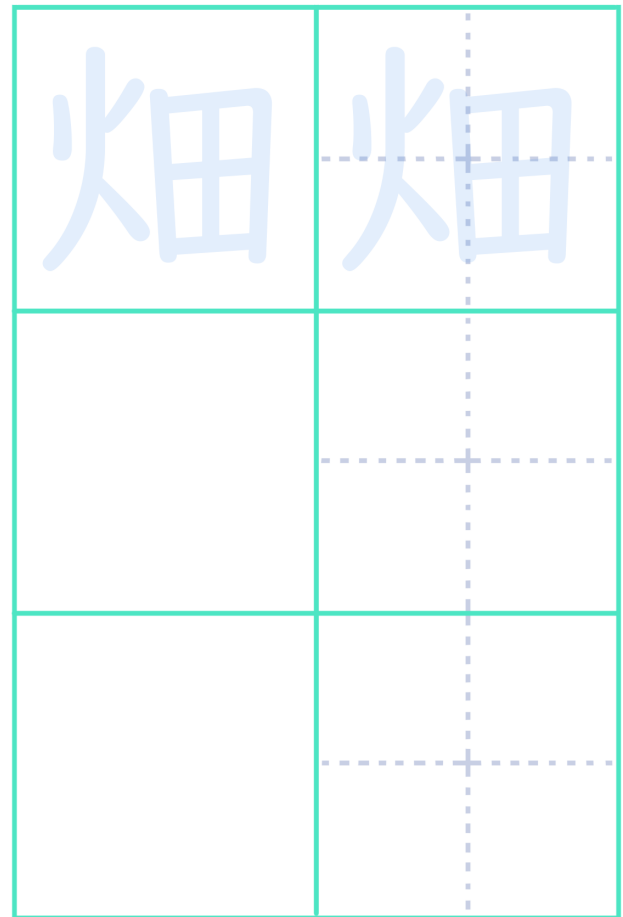

かんじプリント

なまえ

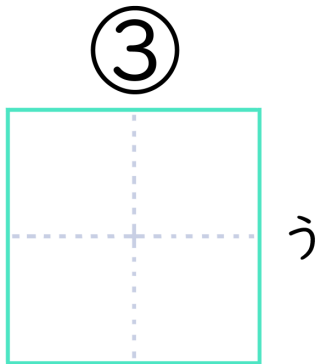
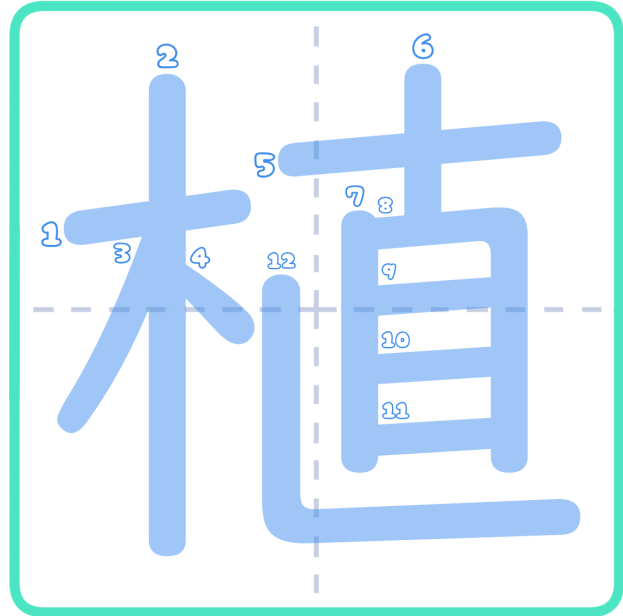

える

① 田<sup>た</sup>植え

くん  
う  
える

おん  
し  
よく

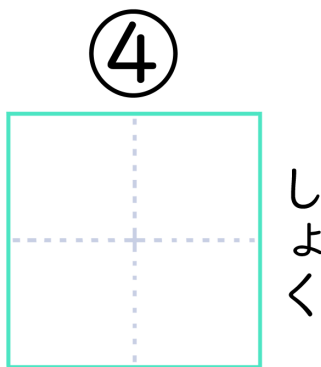

物<sup>もの</sup>

② 植<sup>き</sup>木

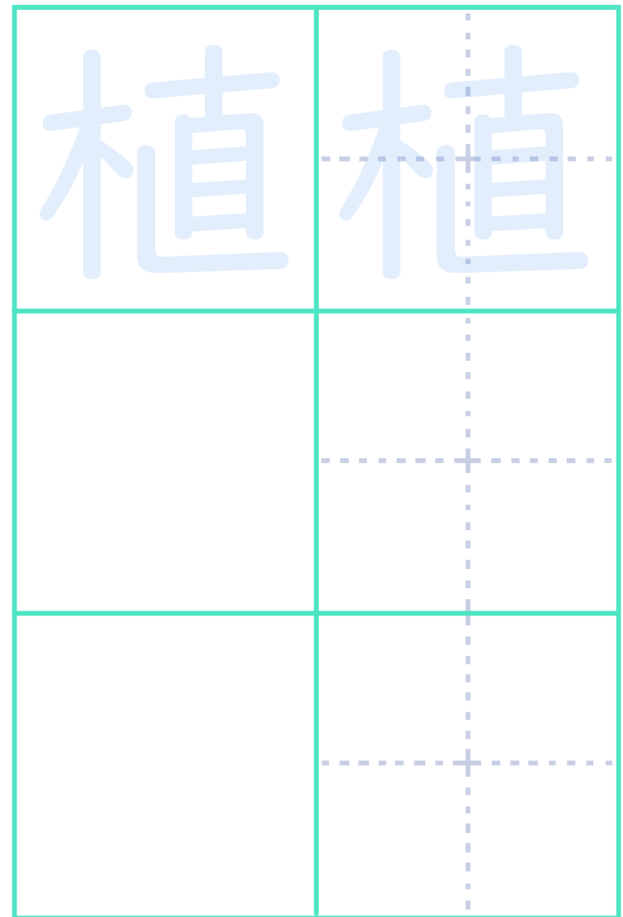

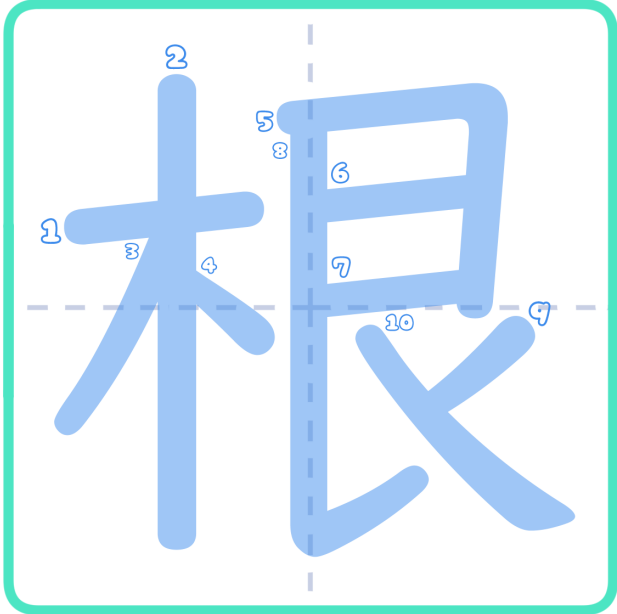
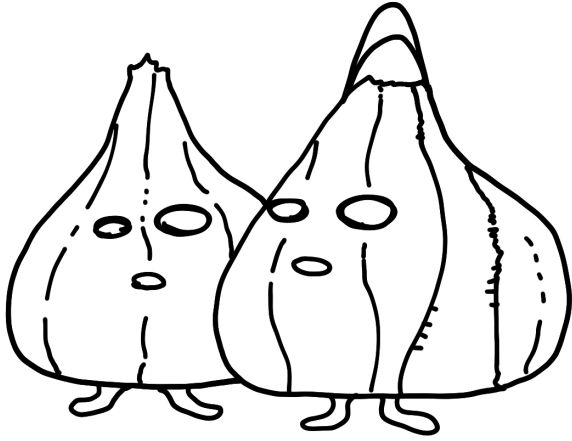

③

ね

元 もと

①

球 きゅう

根

くん

ね

おん

こん

④

こん

気 き

②

屋 や

根

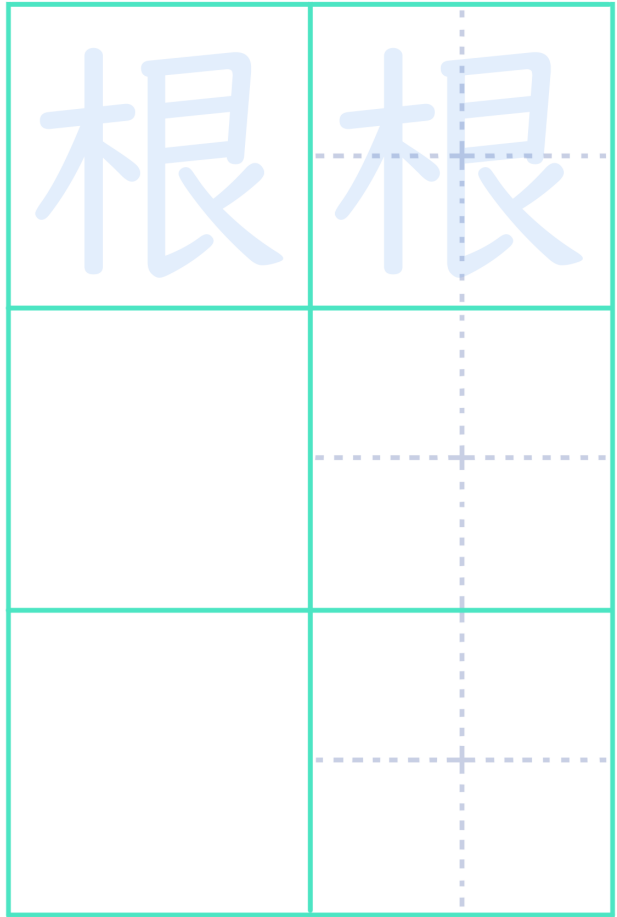

かんじプリント

なまえ

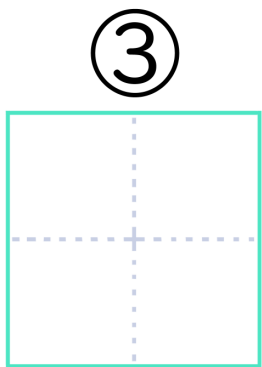
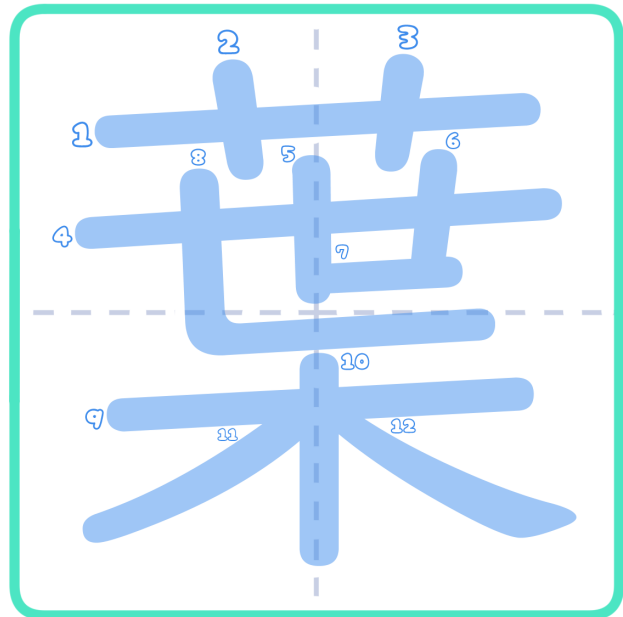

は

っぱ

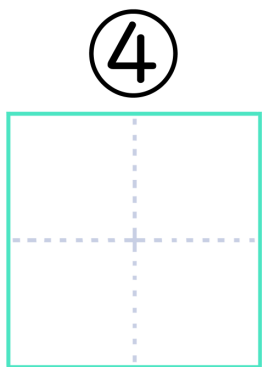

は

巻まき

① 紅葉こうじ

② 落葉らくじ

くん  
は

おん  
よう

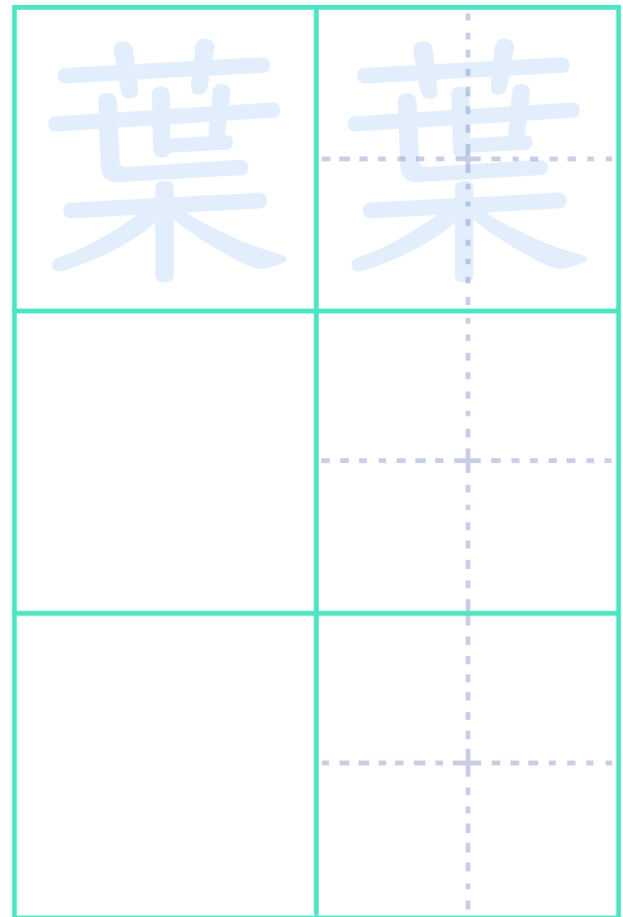

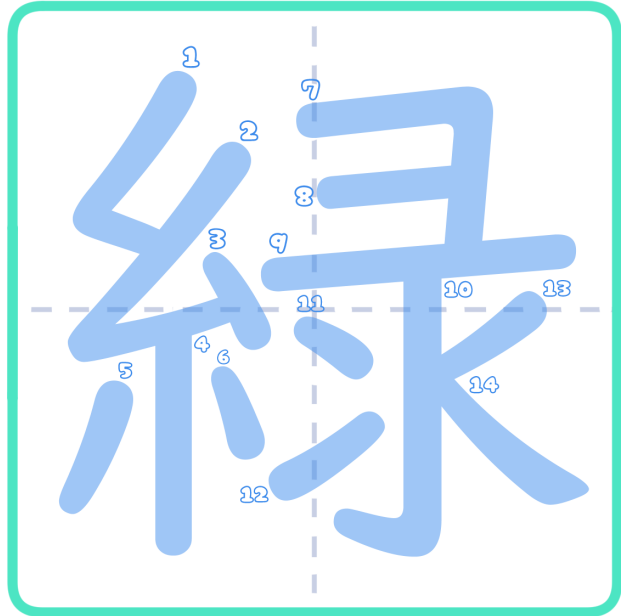
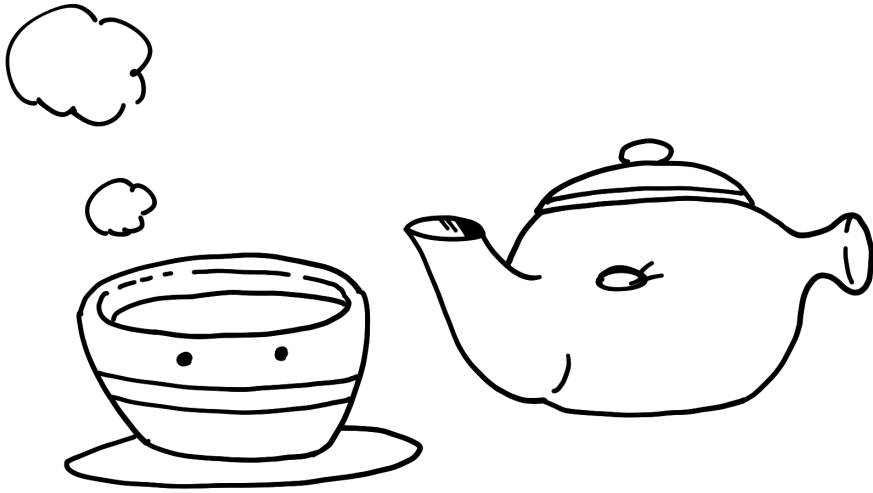

③

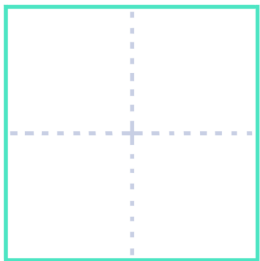

みどり

①

緑色

いろ

くん

みどり

おん

りよく

の

山

やま

④

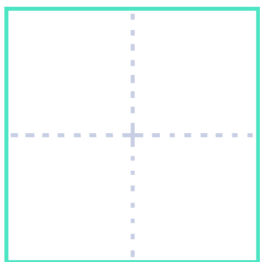

りよく

②

新緑

しん

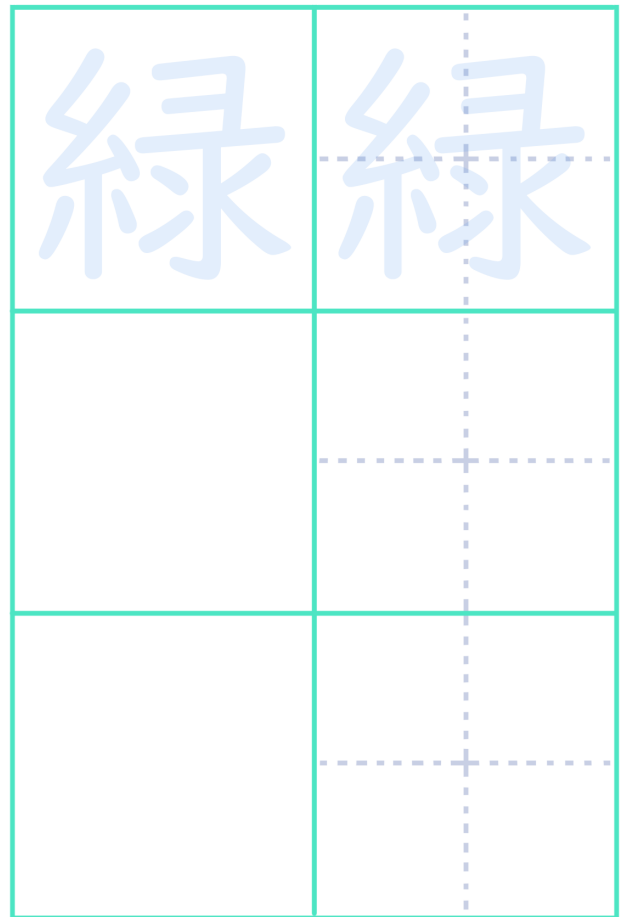

茶

ちや

